

Strong SW & SW *PLUS*



#Creating Smiles

Smiles are the preeminent expression of the happiness we share in special moments with those we love, but they also represent gratitude, respect, and many times, the result of a continuous work.

At S.I.N. Implant System, we believe that the smile of each of our partners help generate even more unique smiles.

Our purpose is to build this affective and virtuous cycle, in which the smile is the biggest and most universal expression of joy.

That is why, for the coming years, we will live by this philosophy even more intensely:

S.I.N. Creating Smiles.



Watch our movie.



IMPLANTAT



Discover IMPLANTAT,
the educational habitat of S.I.N. Implant System.
An online teaching platform created to make
more professionals accelerate their career
and increase their success.

Access
IMPLANTAT.GLOBAL
or scan the QR CODE
and begin your journey of
knowledge now!



EDUCATION POWERED BY S.I.N. IMPLANT SYSTEM



S.I.N.
Implant System



Scientific Evidence

- › Research and development of products in partnership with renowned universities and institutes around the world as:
Aarhus University - Denmark, Chalmers University - Sweden, KU Lueven - Belgium, Malmö University - Sweden, UNESP - Brazil, USP - Brazil, UFU - Brazil, SLmandic - Brazil.

Production Excellence

- › Large investments in technological updating of our manufacturing facilities over the past three years in state-of-the-art equipment.
- › Annual production of over 5 million items.

Global Presence

- › One of the most important implant companies worldwide.
- › Wide international presence.

Guaranteed Quality and Certifications

- › Rigorous quality control of process, from the arrival of the raw material to the delivery of the final product, proven through national and international certifications.

ISO
9001

ISO
13485



ISO
14001

ISO
45001

FDA
510(K) - CLEARED
K051859
K200992
K193096
K203725
K201688
K170392
K170398



Strong SW



DOWNLOAD S.I.N. APP AND
SEE IT IN AUGMENTED REALITY.
Place the cellphone camera over the image.

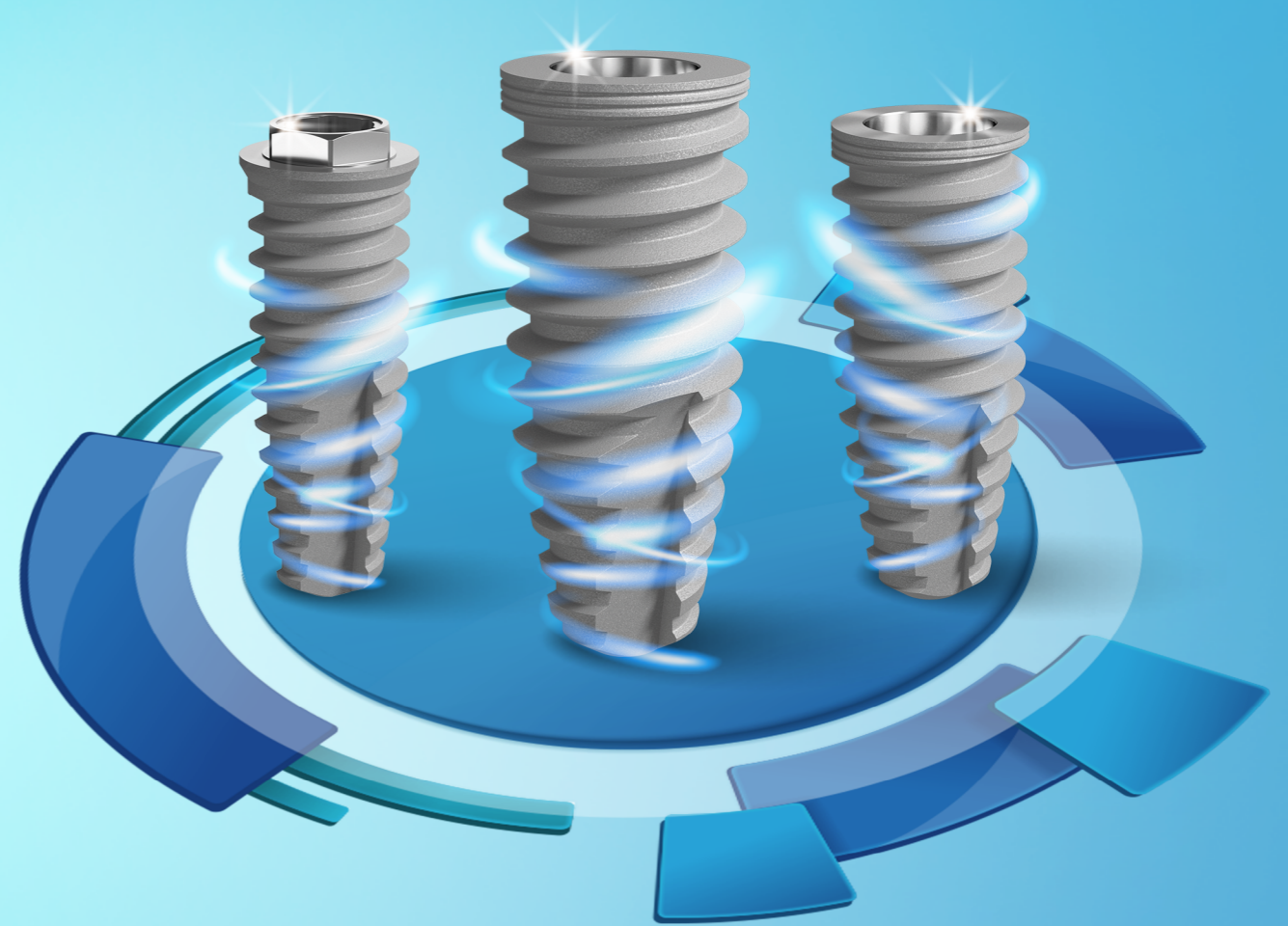

Strong SW PLUS

The versatility of Strong SW line that you already know, with HAnano® surface and accelerated osseointegration. Developed at the most important Swedish universities, this nanosurface considerably accelerates the quality of osseointegration.

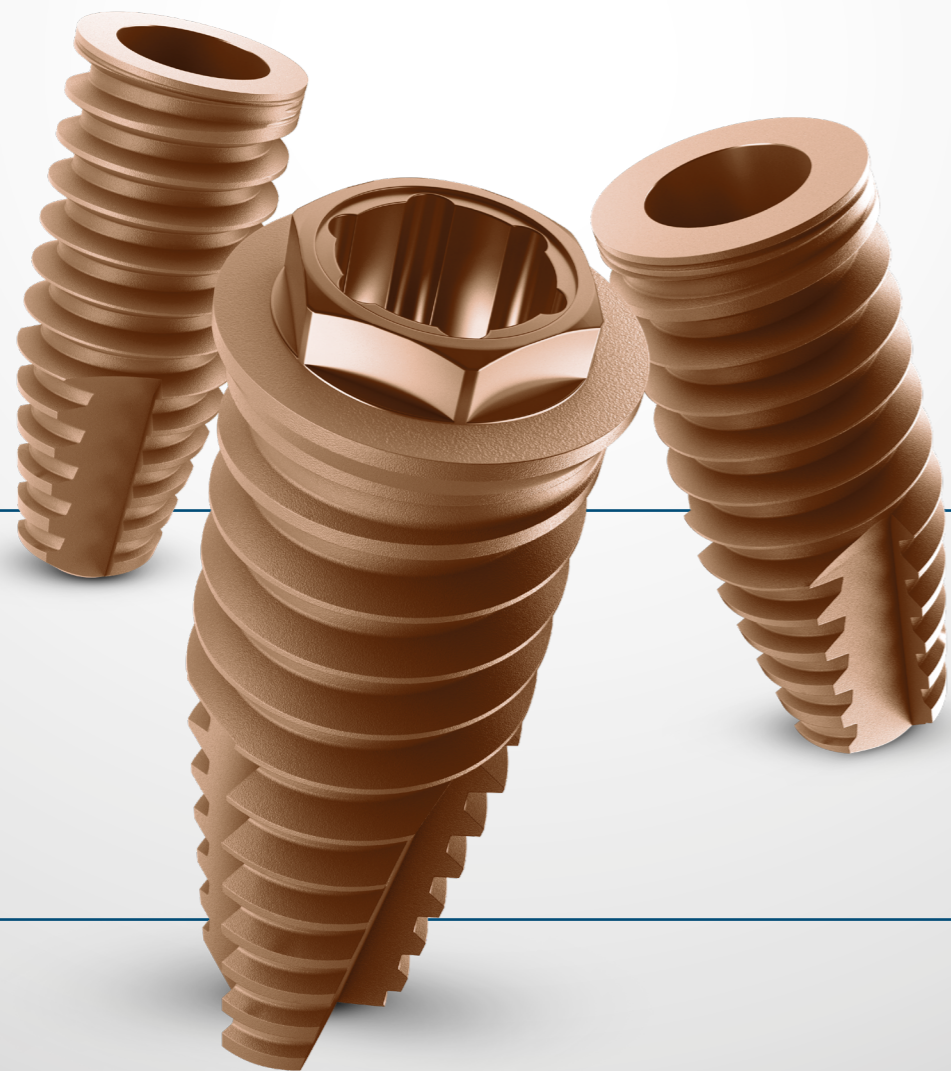

NANOTECHNOLOGY IN FAVOR OF VERSATILITY.

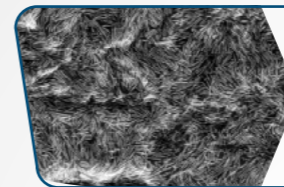

› Exclusive HAnano® surface.

Developed at the main Swedish universities, HAnano® was evaluated by more than 50 preclinical and clinical studies, which verify a faster osseointegration, besides promoting a superior bone quality.

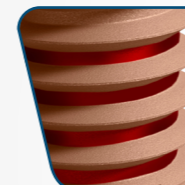

› More bone, more speed.

The high hydrophilicity, which is generated by an ultrafine and homogeneous layer of hydroxyapatite, increases the activity of the proteins involved in the process of osseointegration.



› One implant, many possibilities

The advantages of the best nanosurface of the world in any connection (External Hex., Internal Hex. and Cone Morse).



› Indicated for any bone type.

The hybrid macrogeometry of Strong SW Plus allows the implant installation in any bone density, including after tooth extraction.



› Clinical Convenience.

A single surgical kit for installation of the entire Strong SW and Strong SW Plus line.



› Success verified through a solid scientific research.

With more than one decade in the market, the implants line Strong SW has approximately more than 2.2 million implants sold and approximately 60 scientific papers published around the world. This is proof of the quality and superiority of Strong SW.

HA^{nano} Surface

THINNER, FASTER AND STRONGER

GET TO KNOW THE GOLDEN STANDARD OF OSSEOINTEGRATION

Hydroxyapatite (HA), which is the main mineral present in the natural bone structure, when applied on the surface of nanostructured titanium implants, forms a homogeneous and stable coating functioning as a scar catalyst that speeds up osseointegration when compared to conventional surfaces.

From 2005 on, HAnano® surfaces have been developed by researchers from leading universities in Gothenburg (Sweden). Scientists from several countries have tested and approved its effectiveness, the results of which have been published in dozens of articles in world-renowned scientific journals.

The HAnano® coating is formed by hydroxyapatite nanocrystals, with size and shape similar to those of human bone, sintered on a microrough titanium measuring 20 nm thick that promotes a change on surface energy, increasing the hydrophilicity and

providing substrate that stimulates a greater osteoblasts multiplication. The HAnano® present on the surface of the Unitite and Strong SW Plus implants has shown an improvement in scar response in molecular tests of signal transduction, where the proteins involved in the scar process recorded a substantial increase in concentration, presenting the coating positive effect on the interaction with the pre-osteoblastic cells. Likewise, there was an increase in the concentration of important osteogenic markers, such as alkaline phosphatase and osteocalcin, in a clear signaling of the mineralization process acceleration. Among the most relevant aspects, with the greatest clinical significance, is the bone mechanical quality which is formed around this highly hydrophilic Unitite and Strong SW Plus surface, which derives from the resulting ionic potential of the HAnano®.

The image below shows the SW PLUS surface at an increase of 5.000x / 10.000x / 100.000x respectively. The moderately rough Ti surface with the PLUS of a nano-layer of Hydroxyapatite.

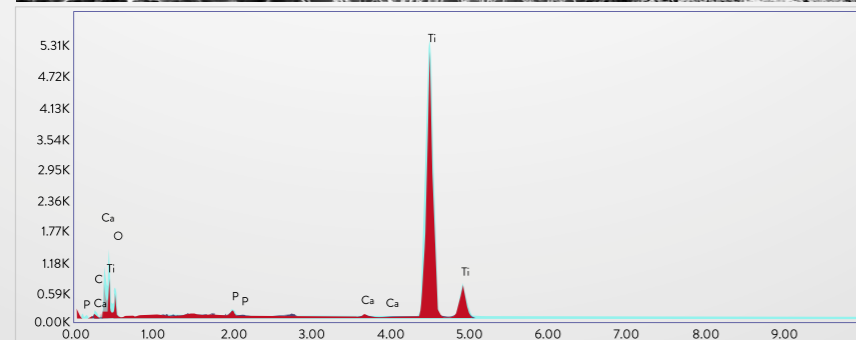
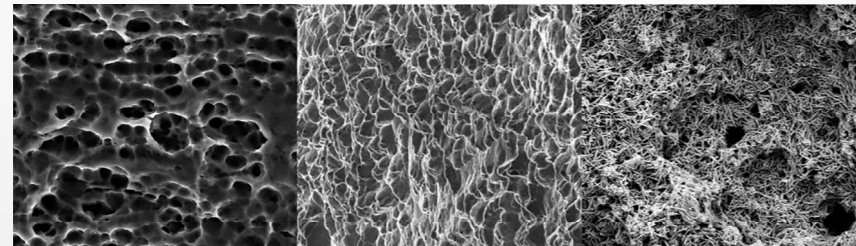

The chart and table above corresponds to an EDS analysis on the SW Plus surface, bringing the purity and stability of the implant surface closer.

*Check the availability of this product in your region

SCIENTIFIC PUBLICATIONS

The positive and superior results of HAnano® have been evaluated and proven by numerous scientific studies in several recognized universities and research institutions worldwide.

NANO HYDROXYAPATITE STRUCTURES INFLUENCE EARLY BONE FORMATION.

Meirelles L, Arvidsson A, Andersson M, Kjellin P, Albrektsson T, Wennerberg A.

Journal of Biomedical Materials Research Part A Volume 87A, Issue 2, 2008, pp. 299-307

THE EFFECT OF CHEMICAL AND NANOTOPOGRAPHICAL MODIFICATIONS ON THE EARLY STAGES OF OSSEOINTEGRATION.

Meirelles L, Currie F, Jacobsson M, Albrektsson T, Wennerberg A.

The International Journal of Oral and Maxillofacial Implants Volume 23, Issue 4, 2008, pp. 641-647

NANO HYDROXYAPATITE COATED IMPLANTS IMPROVE BONE NANOMECHANICAL PROPERTIES.

Jimbo R, Coelho PG, Bryington M, Baldassarri M, Tovar N, Currie F, Hayashi M, Janal MN, Andersson M, Ono D, Vandeweghe S, Wennerberg

A.J Dent Res. 2012;91(12):1172-7



Scanning Electron Microscopy demonstrating osteoblastic cell on HAnano® surface. Courtesy: Cavalcanti JH, Tanaka M, Bezerra FJ, CBPF RJ.

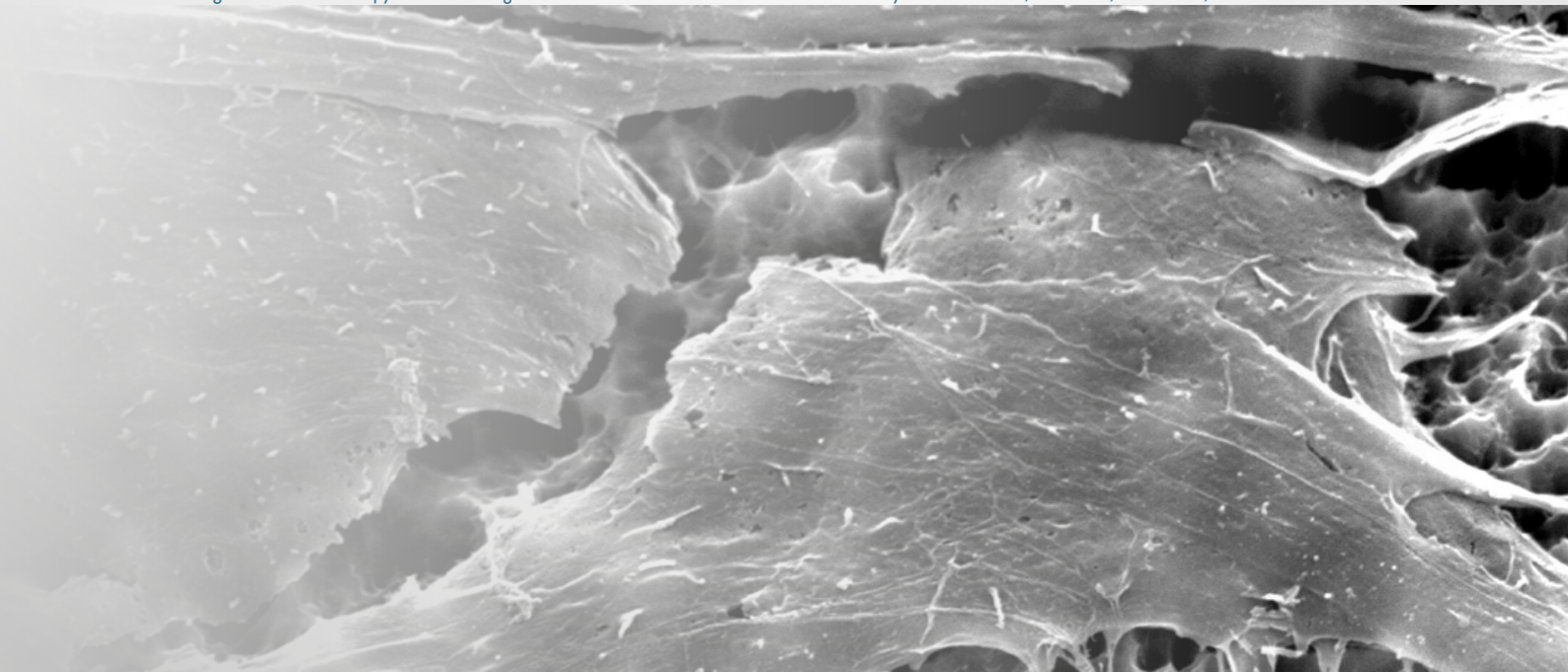

Strong SW

The Strong SW line delivers a unique experience to those professionals who aim for outstanding results. With an exceptional clinical practicality the Strong SW line has a full range of implants.

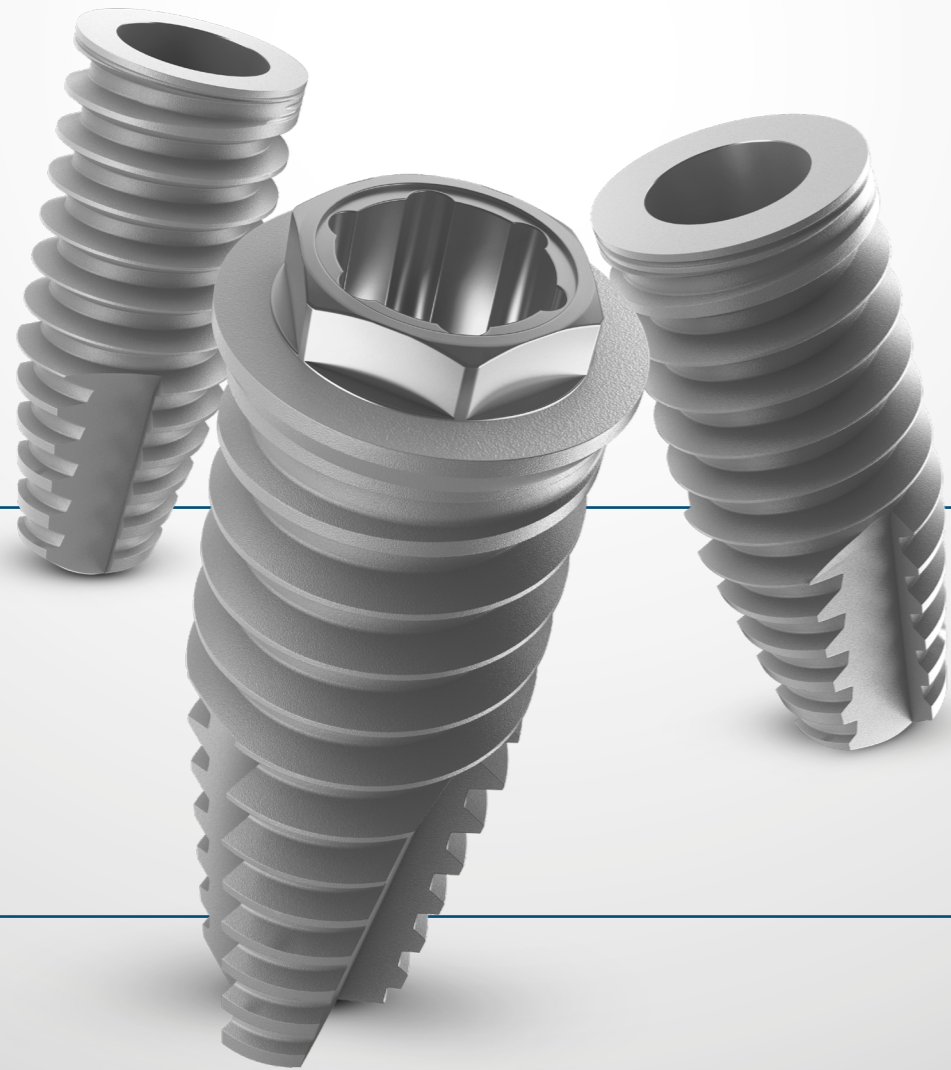

A UNIVERSE OF POSSIBILITIES AND BENEFITS

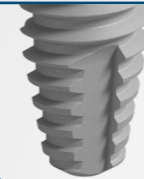

› Apex:

Support and stability for cases of thin bone thickness.



› Cervical microthreads:

Increases the bone contact area and improves the dissipation of occlusal forces.

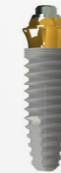

› Accurate fit:

Exclusive prosthetic components and high resistance to dissipate transverse and axial forces.

› Manufactured in Titanium Grade 4:

Extremely light metal, very resistant to corrosion, wear and fracture.



› Hybrid macrogeometry, cylindrical body and conical apex:

Combining the best of tapered and cylindrical implants. Indicated for all bone densities. Full contact between implant and bone.

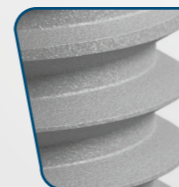

› Trapezoidal thread:

The depth and space of its threads offer high primary stability and faster insertion.

› Ultra Threading:

The sharper profile threads simplify the implant placement.

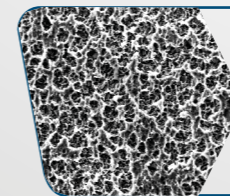

› Complete surface treatment:

Double acid etching up to the cervical area of the implant. The Cone Morse offers the treatment up to the connection area.



› More prosthetic components options for Morse Taper :

Morse taper internal angle available at 16 ° and 11.5 ° (except Plus).

Strong SW

EXTERNAL HEXAGON

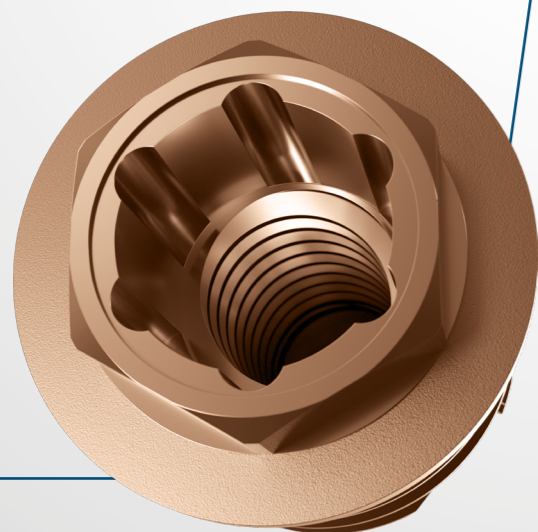
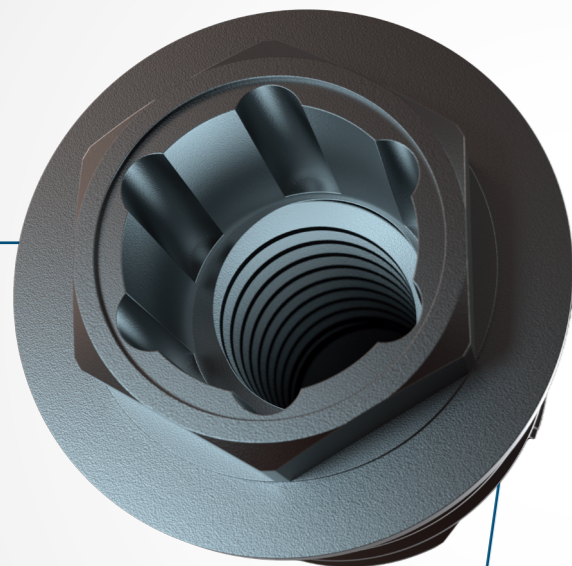

- › Indicated for immediate or late loading rehabilitation and for single or multiple implants.
- › It allows the installation in any type of bone, including post-extraction.
- › Hexalobular connection: Key does not latch, supports higher torque and connection does not deform.
- › Allows Platform Switching technique.
- › 3 key options for installation (contra-angle, ratchet and digital key).

INDICATIONS FOR CLINICAL USE:

- › 3.5 – Central incisors and Lateral
- › 3.75 – Central and lateral superiors, canines and premolars
- › 4.5 – Premolars and Molars
- › 5.0 – Molars

› Bone level installation.

- › Speed of the Initial drills: 1.500 rpm.
- › Speed of the Drills 3.5 to 5.0mm: 800 rpm.
- › Speed of the Bone tap: 25 rpm*
- › Insertion speed: 20 to 40 rpm.
- › Immediate loading: recommended torque from 45 to 80 N.cm.**
- › Late loading: maximum Torque 45 N.cm.

* The use of the bone tap is optional in bone type I and II because it is a compressive implant, however the maximum torque must always be respected.

** Relative contraindication in patients with systemic or local problems and at professional's discretion.

DRILLING SEQUENCE GUIDE

		1500 rpm			800 rpm				25 rpm				
		FRLD	FHD	FRWD	FRWD	FCWD	FRWD	FRWD	CMRIW	CMRIW	CMRIW	CMRIW	CMRIW
PLAT. (mm)	DIAM. (mm)	2020 Ø 2.0	2015 Ø 2.0	35 Ø 3.05	38 Ø 3.3	41 Ø 4.1	45 Ø 4.0	50 Ø 4.25	35 Ø 3.5	37 Ø 3.75	38 Ø 3.8	45 Ø 4.5	50 Ø 5.0
Strong SW	3.6	•	•	•									
Strong SW Plus	4.1	•	•	•	•	•							
	4.5	•	•	•	•		•					•	
	5	•	•	•	•		•	•					•

• The use of the bone tap is optional in bone type I and II because it is a compressive implant, however the maximum torque must always be respected.

Technical measures

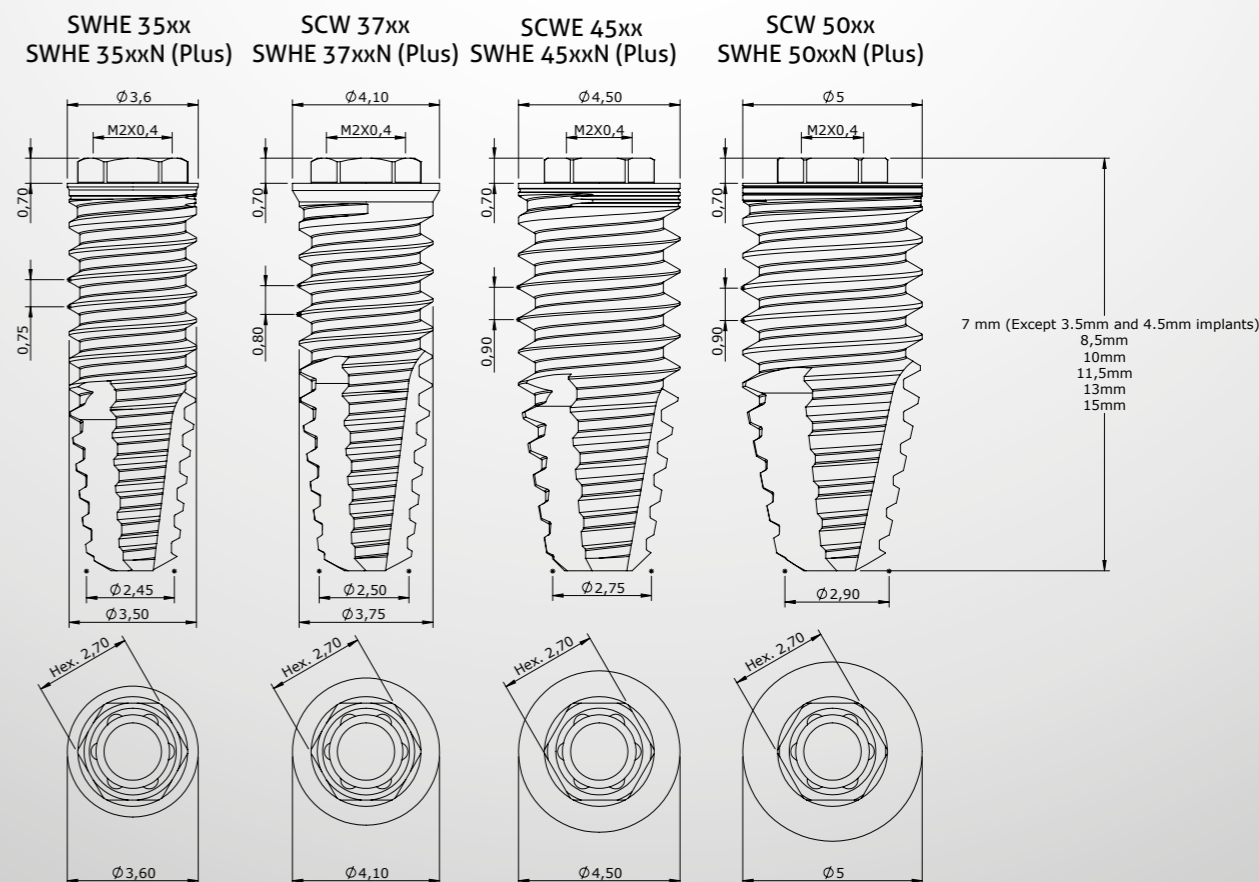



3.6 FIT

Platform Switching is a technique where the diameter of the component used is smaller than the implant platform diameter; thus, a 90 degree “step” is created between the implant and the component.

S.I.N. Implant System brings the best of this concept to Strong SW line.

- › A line of 3.6 mm components for 4.1 mm implants.
- › It helps on the maintenance of the bone levels.
- › It simplifies the clinical settlement of the prosthesis components.
- › It improves the dissipation of forces in the cervical region of the implant. It minimizes the marginal bone loss.
- › It improves the marginal sealing for a better settlement of the peri-implant tissue.
- › It promotes a better aesthetics, and rehabilitation with the highest biocompatibility.



EXTERNAL HEX PROSTHETIC SEQUENCE

DIRECT SEQUENCE OVER THE IMPLANT

3.6 FIT, 4.1 E 5.0 REGULAR

Single or Multiple

COMPATIBLE WITH LINE



IMPLANT

CODE SW	CODE SW PLUS	DIAM. (mm)	LENGTH (mm)	PLAT. (mm)
SWHE 3585	SWHE 3585N	3.5	8.5	3.6
SWHE 3510	SWHE 3510N	3.5	10	3.6
SWHE 3511	SWHE 3511N	3.5	11.5	3.6
SWHE 3513	SWHE 3513N	3.5	13	3.6
SWHE 3515	SWHE 3515N	3.5	15	3.6
SCW 3707	SWHE 3707N	3.75	7	4.1
SCW 3785	SWHE 3785N	3.75	8.5	4.1
SCW 3710	SWHE 3710N	3.75	10	4.1
SCW 3711	SWHE 3711N	3.75	11.5	4.1
SCW 3713	SWHE 3713N	3.75	13	4.1
SCW 3715	SWHE 3715N	3.75	15	4.1
SCWE 4585	SWHE 4585N	4.5	8.5	4.5
SCWE 4510	SWHE 4510N	4.5	10	4.5
SCWE 4511	SWHE 4511N	4.5	11.5	4.5
SCWE 4513	SWHE 4513N	4.5	13	4.5
SCWE 4515	SWHE 4515N	4.5	15	4.5
SCW 5007	SWHE 5007N	5	7	5
SCW 5085	SWHE 5085N	5	8.5	5
SCW 5010	SWHE 5010N	5	10	5
SCW 5011	SWHE 5011N	5	11.5	5
SCW 5013	SWHE 5013N	5	13	5
SCW 5015	SWHE 5015N	5	15	5



TITANIUM HEALING CAP

CODE	DIAM. (mm)	LENGTH (mm)
TI 3600	3.6	1
TI 3602	3.6	2
CIHE 3602	4.0	2
CIHE 3604	4.0	4
CIHE 3606	4.0	6
CI 4102	4.1	2
CI 4104	4.1	4
CI 3602	5	2
CI 3604	5	4
CI 4154	5	4
CI 4156	5	6
CI 4158	5	8
CI 5052	5.5	2
CI 5054	5.5	4
CI 5056	5.5	6
CI 5058	5.5	8



PEEK HEALING CAP

CODE	DIAM. PLAT. (mm)	PROFILE DIAM. (mm)	LENGTH (mm)
CPHE 3505	3.5	5	6
CPHE 3508	3.5	8	6
CPHE 4108	4.1	8	6
CPHE 5008	5.0	8	6



OPEN TRAY TRANSFER

CODE	PLAT. (mm)
TMAHE 36	3.6
TMAI 3605	3.6
TMAI 4105	4.1
TMAI 5005	5.0



CLOSED TRAY TRANSFER

CODE	PLAT. (mm)
TMFHE 36	3.6
TMFI 3605	3.6
TMFI 4105	4.1
TMFI 5005	5.0



ANALOG

CODE
ANHE 3600
AN 4100
AN 5000



TEMPORARY TITANIUM CYLINDER

CODE	PLAT. (mm)
CPTHE 360-H	3.6
CPTHE 366-H	3.6
CPT 360-H	3.6
CPT 366-H	3.6
CPT 400-H	4.1
CPT 406-H	4.1
CPT 500-H	5.0
CPT 506-H	5.0

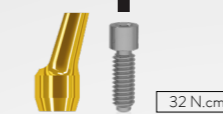

17° ANGLED CEMENTED ABUTMENT

CODE	PLAT. (mm)	LENGTH (mm)
AIA 3651-Q	3.6	1.0
AIA 3652-Q	3.6	2.0
AIA 3653-Q	3.6	3.0
AIA 3654-Q	3.6	4.0
AIA 4151-Q	4.1	1.0
AIA 4152-Q	4.1	2.0
AIA 4154-Q	4.1	4.0
AIA 5052-Q	5.0	2.0
AIA 5054-Q	5.0	4.0

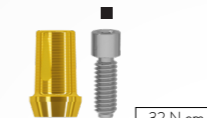

STRAIGHT CEMENTED ABUTMENT

CODE	PLAT. (mm)	LENGTH (mm)
AI 3651-Q	3.6	1.0
AI 3652-Q	3.6	2.0
AI 3653-Q	3.6	3.0
AI 3654-Q	3.6	4.0
AI 4151-Q	4.1	1.0
AI 4152-Q	4.1	2.0
AI 4153-Q	4.1	3.0
AI 4154-Q	4.1	4.0
AI 5051-Q	5.0	1.0
AI 5052-Q	5.0	2.0
AI 5053-Q	5.0	3.0
AI 5054-Q	5.0	4.0



CO-CR ABUTMENT

CODE
EUCLAHE 360-Q
EUCLAHE 366-Q
EUCLA 360-Q
EUCLA 366-Q
EUCLA 400-Q
EUCLA 406-Q
EUCLA 500-Q
EUCLA 506-Q

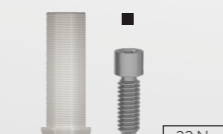

PLASTIC ABUTMENT

CODE
UCLAHE 360-Q
UCLAHE 366-Q
UCLA 360-Q
UCLA 366-Q
UCLA 400-Q
UCLA 406-Q
UCLA 500-Q
UCLA 506-Q



LABORATORY SCREW

CODE	Hex. externo
PLPA 1	Hex. externo
PTMA 22-1	2.0 mm screw



RETAINING SCREW

CODE	
PTQ 2008	Titanium Squared
PT 2008	Titanium Hex.
	2.0 mm screw



POLISHING PROTECTOR

CODE
PPI 41
PPI 4100

- *Hex Screw
- ⊙ *Anti-Rotational Component
- *Square Screw
- ⬡ *Abutment Screw

* For Ø 3.5 External Hex implants, consider components marked in bold.

* Check the availability of the products in your region.

3.5 EXTERNAL HEX PROSTHETIC SEQUENCE

UNIVERSAL ABUTMENT

Single cemented

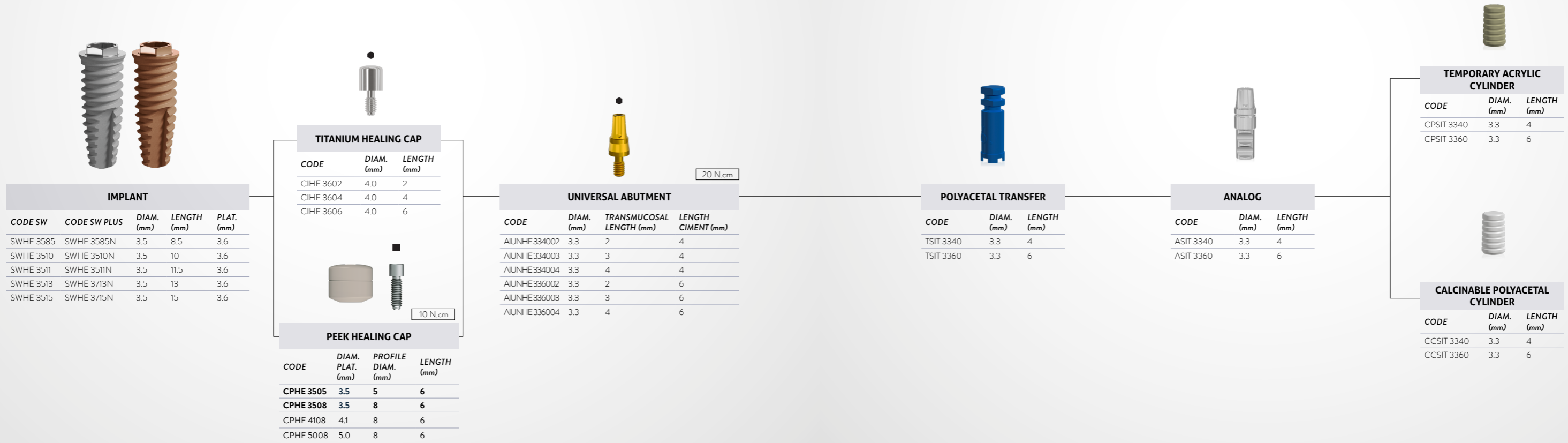

* Check the availability of the products in your region.

- *Hex Screw
- ⊙ *Anti-Rotational Component
- *Square Screw
- ⬡ *Abutment Screw
- ⊙ *Rotational component

EXTERNAL HEX PROSTHETIC SEQUENCE

MULTI-UNIT ABUTMENT

MULTIPLE SCREW RETAINED RESTORATIONS



IMPLANT

CODE SW	CODE SW PLUS	DIAM. (mm)	LENGTH (mm)	PLAT. (mm)
SWHE 3585	SWHE 3585N	3.5	8.5	3.6
SWHE 3510	SWHE 3510N	3.5	10	3.6
SWHE 3511	SWHE 3511N	3.5	11.5	3.6
SWHE 3513	SWHE 3513N	3.5	13	3.6
SWHE 3515	SWHE 3515N	3.5	15	3.6
SCW 3707	SWHE 3707N	3.75	7	4.1
SCW 3785	SWHE 3785N	3.75	8.5	4.1
SCW 3710	SWHE 3710N	3.75	10	4.1
SCW 3711	SWHE 3711N	3.75	11.5	4.1
SCW 3713	SWHE 3713N	3.75	13	4.1
SCW 3715	SWHE 3715N	3.75	15	4.1
SCWE 4585	SWHE 4585N	4.5	8.5	4.5
SCWE 4510	SWHE 4510N	4.5	10	4.5
SCWE 4511	SWHE 4511N	4.5	11.5	4.5
SCWE 4513	SWHE 4513N	4.5	13	4.5
SCWE 4515	SWHE 4515N	4.5	15	4.5
SCW 5007	SWHE 5007N	5	7	5
SCW 5085	SWHE 5085N	5	8.5	5
SCW 5010	SWHE 5010N	5	10	5
SCW 5011	SWHE 5011N	5	11.5	5
SCW 5013	SWHE 5013N	5	13	5
SCW 5015	SWHE 5015N	5	15	5



STRAIGHT MULTI-UNIT ABUTMENT

CODE	PLAT. (mm)	LENGTH (mm)	DIAM. (mm)
MA 3601	3.6	1	4.8
MA 3602	3.6	2	4.8
MA 3603	3.6	3	4.8
MA 3604	3.6	4	4.8
MA 4101	4.1	1	4.8
MA 4102	4.1	2	4.8
MA 4103	4.1	3	4.8
MA 4104	4.1	4	4.8
MA 5001	5	1	4.8
MA 5002	5	2	4.8
MA 5003	5	3	4.8
MA 5004	5	4	4.8



17° ANGLED MULTI-UNIT ABUTMENT

CODE	PLAT. (mm)	LENGTH (mm)	DIAM. (mm)
MAA 3602	3.6	2	4.8
MAA 3604	3.6	4	4.8
MAA 4102	4.1	2	4.8
MAA 4103	4.1	3	4.8



17° ANGLED MULTI-UNIT ABUTMENT

CODE	PLAT. (mm)	LENGTH (mm)	DIAM. (mm)
MAA 3632	3.6	2	4.8
MAA 3634	3.6	4	4.8
MAA 4132	4.1	2	4.8
MAA 4134	4.1	4	4.8

COMPATIBLE WITH LINE



OPEN TRAY TRANSFER

CODE

TMAM 4800



ABUTMENT PROTECTOR

CODE
PMA 4855
Perfil de 5.0 mm



CLOSED TRAY TRANSFER

CODE

TMFM 4800



ANALOG

CODE
ANMA 4800



TEMPORARY TITANIUM CYLINDER

CODE

PTM 4800-2 For angled multi-unit
PTM 4800-3 For straight multi-unit
PTMS 4800-3 Indicado para solda de laser For straight multi-unit



CALCINABLE AND CO-CR CYLINDER

CODE

CPM 4800-2 For angled multi-unit
CPM 4800-3 For straight multi-unit
CLEM 4800-2 Cobalt chrome for angled multi-unit
CLEM 4800-3 Cobalt chrome for straight multi-unit



POLISHING PROTECTOR

CODE
PPM 01



LABORATORY SCREW

CODE	DIAM. (mm)
PL 1405 short	1,4
PTMA 13-1 long	1,4



PARAFUSO DE RETENÇÃO

CODE	LENGTH (mm)	
PRH 20	2	For angled multi-unit
PRH 30	3	For straight multi-unit

* For Ø 3.5 External Hex implants, consider components marked in bold.

* Check the availability of the products in your region.

● *Hex Screw
⊙ *Anti-Rotational Component
■ *Square Screw
⬡ *Abutment Screw

EXTERNAL HEX PROSTHETIC SEQUENCE

MICRO-MINI-ABUTMENT - INTERMEDIÁRIO PROTÉTICO PARAFUSADO

Próteses unitárias, parciais ou totais parafusadas

COMPATIBLE WITH LINE



IMPLANT

CODE SW	CODE SW PLUS	DIAM. (mm)	LENGTH (mm)	PLAT. (mm)
SWHE 3585	SWHE 3585N	3.5	8.5	3.6
SWHE 3510	SWHE 3510N	3.5	10	3.6
SWHE 3511	SWHE 3511N	3.5	11.5	3.6
SWHE 3513	SWHE 3513N	3.5	13	3.6
SWHE 3515	SWHE 3515N	3.5	15	3.6
SCW 3707	SWHE 3707N	3.75	7	4.1
SCW 3785	SWHE 3785N	3.75	8.5	4.1
SCW 3710	SWHE 3710N	3.75	10	4.1
SCW 3711	SWHE 3711N	3.75	11.5	4.1
SCW 3713	SWHE 3713N	3.75	13	4.1
SCW 3715	SWHE 3715N	3.75	15	4.1
SCWE 4585	SWHE 4585N	4.5	8.5	4.5
SCWE 4510	SWHE 4510N	4.5	10	4.5
SCWE 4511	SWHE 4511N	4.5	11.5	4.5
SCWE 4513	SWHE 4513N	4.5	13	4.5
SCWE 4515	SWHE 4515N	4.5	15	4.5
SCW 5007	SWHE 5007N	5	7	5
SCW 5085	SWHE 5085N	5	8.5	5
SCW 5010	SWHE 5010N	5	10	5
SCW 5011	SWHE 5011N	5	11.5	5
SCW 5013	SWHE 5013N	5	13	5
SCW 5015	SWHE 5015N	5	15	5

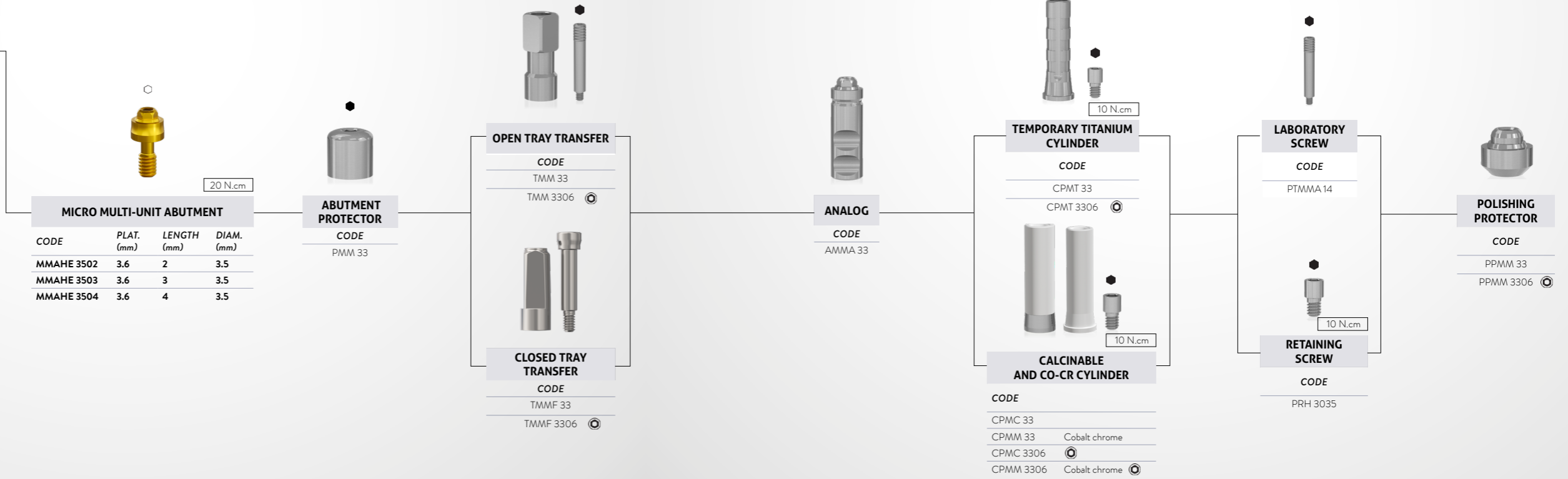

* For Ø 3.5 External Hex implants, consider components marked in bold.

* Check the availability of the products in your region.

*Hex Screw
 *Anti-Rotational Component
 *Square Screw
 *Abutment Screw

EXTERNAL HEX PROSTHETIC SEQUENCE

CONICAL ABUTMENT

SINGLE/MULTIPLE SCREW RETAINED RESTORATIONS

COMPATIBLE WITH LINE



20 N.cm



OPEN TRAY TRANSFER

CODE

TMAA 4800
TMAA 4806



CLOSED TRAY TRANSFER

CODE

TMFA 4800
TMFA 4806



ANALOG

CODE

ANAC



10 N.cm

TEMPORARY TITANIUM CYLINDER

CODE

PTA 4800-3
PTA 4806-3



10 N.cm

CALCINABLE AND CR-CO CYLINDER

CODE

CPAC 00-3 Plastic
CALE 00-3 Cobalt chrome
CPAC 06-3 Plastic
CALE 06-3 Cobalt chrome



POLISHING PROTECTOR

CODE

PPAC 01



LABORATORY SCREW

CODE DIAM. (mm)

PL 1405 Short 1.4
PTMA 13-1 Long 1.4



10 N.cm

RETAINING SCREW

CODE COMP. (mm)

PRH 30 3

IMPLANT

CODE SW	CODE SW PLUS	DIAM. (mm)	LENGTH (mm)	PLAT. (mm)
SWHE 3585	SWHE 3585N	3.5	8.5	3.6
SWHE 3510	SWHE 3510N	3.5	10	3.6
SWHE 3511	SWHE 3511N	3.5	11.5	3.6
SWHE 3513	SWHE 3513N	3.5	13	3.6
SWHE 3515	SWHE 3515N	3.5	15	3.6
SCW 3707	SWHE 3707N	3.75	7	4.1
SCW 3785	SWHE 3785N	3.75	8.5	4.1
SCW 3710	SWHE 3710N	3.75	10	4.1
SCW 3711	SWHE 3711N	3.75	11.5	4.1
SCW 3713	SWHE 3713N	3.75	13	4.1
SCW 3715	SWHE 3715N	3.75	15	4.1
SCWE 4585	SWHE 4585N	4.5	8.5	4.5
SCWE 4510	SWHE 4510N	4.5	10	4.5
SCWE 4511	SWHE 4511N	4.5	11.5	4.5
SCWE 4513	SWHE 4513N	4.5	13	4.5
SCWE 4515	SWHE 4515N	4.5	15	4.5
SCW 5007	SWHE 5007N	5	7	5
SCW 5085	SWHE 5085N	5	8.5	5
SCW 5010	SWHE 5010N	5	10	5
SCW 5011	SWHE 5011N	5	11.5	5
SCW 5013	SWHE 5013N	5	13	5
SCW 5015	SWHE 5015N	5	15	5

CONICAL ABUTMENT HE

CODE	PLAT. (mm)	LENGTH (mm)	DIAM. (mm)
AC 3601	3.6	1	4.8
AC 3602	3.6	2	4.8
AC 3603	3.6	3	4.8
AC 3604	3.6	4	4.8
AC 4101	4.1	1	4.8
AC 4102	4.1	2	4.8
AC 4103	4.1	3	4.8
AC 4104	4.1	4	4.8
AC 5001	5	1	4.8
AC 5002	5	2	4.8
AC 5003	5	3	4.8
AC 5004	5	4	4.8

ABUTMENT PROTECTOR

CODE
PA 4855
5.0 mm profile

* For Ø 3.5 External Hex implants, consider components marked in bold.

* Check the availability of the products in your region.

- *Hex Screw
- *Anti-Rotational Component
- *Square Screw
- *Abutment Screw

EXTERNAL HEX PROSTHETIC SEQUENCE

OVERDENTURE SOLUTIONS BAR-CLIP ATTACHMENT

COMPATIBLE WITH LINE

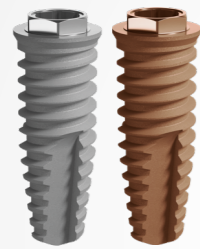

TITANIUM HEALING CAP

CODE	DIAM. (mm)	LENGTH (mm)
CIHE 3602	4.0	2
CIHE 3604	4.0	4
CIHE 3606	4.0	6
CI 4102	4.1	2
CI 3604	5	4
CI 4154	5	4
CI 3606	5	6
CI 4156	5	6
CI 4158	5	8
CI 5052	5.5	2
CI 5054	5.5	4
CI 5056	5.5	6
CI 5058	5.5	8
CI 3602	5	2
CI 4104	4.1	4
CI 4152	5	2



PEEK HEALING CAP

CODE	DIAM. DA PLAT. (mm)	PRO-FILE DIAM. (mm)	LENGTH (mm)
CPHE 3505	3.5	5	6
CPHE 3508	3.5	8	6
CPHE 4108	4.1	8	6
CPHE 5008	5.0	8	6

10 N.cm



OPEN TRAY TRANSFER

CODE	PLAT. (mm)
TMAHE 36	3.6
TMAI 3605	3.6
TMAI 4105	4.1
TMAI 5005	5.0



CLOSED TRAY TRANSFER

CODE	PLAT. (mm)
TMFHE 36	3.6
TMFI 3605	3.6
TMFI 4105	4.1
TMFI 5005	5.0



ANALOG

CODE
ANHE 3600
AN 4100
AN 5000



32 N.cm

CO-CR ABUTMENT

CODE

EUCLAHE 360-Q
EUCLAHE 366-Q
EUCLA 360-Q
EUCLA 400-Q
EUCLA 406-Q
EUCLA 500-Q
EUCLA 506-Q



32 N.cm

PLASTIC ABUTMENT

CODE

UCLAHE 360-Q
UCLAHE 366-Q
UCLA 360-Q
UCLA 400-Q
UCLA 406-Q
UCLA 500-Q
UCLA 506-Q

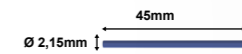

OVERDENTURE WIRE

CODE
FO 01
Polyacetal

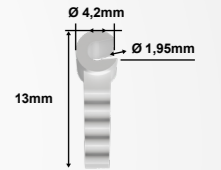

PLASTIC CLIP

CODE
CLIPP

IMPLANT

CODE SW	CODE SW PLUS	DIAM. (mm)	LENGTH (mm)	PLAT. (mm)
SWHE 3585	SWHE 3585N	3.5	8.5	3.6
SWHE 3510	SWHE 3510N	3.5	10	3.6
SWHE 3511	SWHE 3511N	3.5	11.5	3.6
SWHE 3513	SWHE 3513N	3.5	13	3.6
SWHE 3515	SWHE 3515N	3.5	15	3.6
SCW 3707	SWHE 3707N	3.75	7	4.1
SCW 3785	SWHE 3785N	3.75	8.5	4.1
SCW 3710	SWHE 3710N	3.75	10	4.1
SCW 3711	SWHE 3711N	3.75	11.5	4.1
SCW 3713	SWHE 3713N	3.75	13	4.1
SCW 3715	SWHE 3715N	3.75	15	4.1
SCWE 4585	SWHE 4585N	4.5	8.5	4.5
SCWE 4510	SWHE 4510N	4.5	10	4.5
SCWE 4511	SWHE 4511N	4.5	11.5	4.5
SCWE 4513	SWHE 4513N	4.5	13	4.5
SCWE 4515	SWHE 4515N	4.5	15	4.5
SCW 5007	SWHE 5007N	5	7	5
SCW 5085	SWHE 5085N	5	8.5	5
SCW 5010	SWHE 5010N	5	10	5
SCW 5011	SWHE 5011N	5	11.5	5
SCW 5013	SWHE 5013N	5	13	5
SCW 5015	SWHE 5015N	5	15	5

EXTERNAL HEX.

* For Ø 3.5 External Hex implants, consider components marked in bold.
 * Check the availability of the products in your region.

⬢ *Hex Screw
 ⦿ *Anti-Rotational Component
 ■ *Square Screw
 ◻ *Abutment Screw

EXTERNAL HEX PROSTHETIC SEQUENCE

OVERDENTURE SOLUTIONS
MULTI-UNIT + BAR-CLIP RESTORATIONS

COMPATIBLE WITH LINE



IMPLANT

CODE SW	CODE SW PLUS	DIAM. (mm)	LENGTH (mm)	PLAT. (mm)
SWHE 3585	SWHE 3585N	3.5	8.5	3.6
SWHE 3510	SWHE 3510N	3.5	10	3.6
SWHE 3511	SWHE 3511N	3.5	11.5	3.6
SWHE 3513	SWHE 3513N	3.5	13	3.6
SWHE 3515	SWHE 3515N	3.5	15	3.6
SCW 3707	SWHE 3707N	3.75	7	4.1
SCW 3785	SWHE 3785N	3.75	8.5	4.1
SCW 3710	SWHE 3710N	3.75	10	4.1
SCW 3711	SWHE 3711N	3.75	11.5	4.1
SCW 3713	SWHE 3713N	3.75	13	4.1
SCW 3715	SWHE 3715N	3.75	15	4.1
SCWE 4585	SWHE 4585N	4.5	8.5	4.5
SCWE 4510	SWHE 4510N	4.5	10	4.5
SCWE 4511	SWHE 4511N	4.5	11.5	4.5
SCWE 4513	SWHE 4513N	4.5	13	4.5
SCWE 4515	SWHE 4515N	4.5	15	4.5
SCW 5007	SWHE 5007N	5	7	5
SCW 5085	SWHE 5085N	5	8.5	5
SCW 5010	SWHE 5010N	5	10	5
SCW 5011	SWHE 5011N	5	11.5	5
SCW 5013	SWHE 5013N	5	13	5
SCW 5015	SWHE 5015N	5	15	5



STRAIGHT MULTI-UNIT ABUTMENT

CODE	PLAT. (mm)	LENGTH (mm)	DIAM. (mm)
MA 3601	3.6	1	4.8
MA 3602	3.6	2	4.8
MA 3603	3.6	3	4.8
MA 3604	3.6	4	4.8
MA 4101	4.1	1	4.8
MA 4102	4.1	2	4.8
MA 4103	4.1	3	4.8
MA 4104	4.1	4	4.8
MA 5001	5	1	4.8
MA 5002	5	2	4.8
MA 5003	5	3	4.8
MA 5004	5	4	4.8



17° ANGLED MULTI-UNIT ABUTMENT

CODE	PLAT. (mm)	LENGTH (mm)	DIAM. (mm)
MAA 3602	3.6	2	4.8
MAA 3604	3.6	4	4.8
MAA 4102	4.1	2	4.8
MAA 4103	4.1	3	4.8



30° ANGLED MULTI-UNIT ABUTMENT

CODE	PLAT. (mm)	LENGTH (mm)	DIAM. (mm)
MAA 3632	3.6	2	4.8
MAA 3634	3.6	4	4.8
MAA 4132	4.1	2	4.8
MAA 4134	4.1	4	4.8

PROTECTOR ABUTMENT

CODE

PMA 4855

OPEN TRAY TRANSFER

CODE

TMAM 4800

CLOSED TRAY TRANSFER

CODE

TMFM 4800

ANALOG

CODE

ANMA 4800

CO-CR CYLINDER

CODE

CLEM 4800-2 MA Angulado
CLEM 4800-3 MA Reto

CALCINABLE CYLINDER

CODE

CPM 4800-2 For angled multi-unit
CPM 4800-3 For straight multi-unit

OVERDENTURE WIRE

CODE

FO 01
Polyacetal

PLASTIC CLIP

CODE

CLIPP

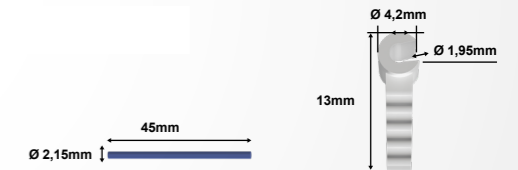

* For Ø 3.5 External Hex implants, consider components marked in bold.

* Check the availability of the products in your region.

● *Hex Screw
⊙ *Anti-Rotational Component
■ *Square Screw
⬢ *Abutment Screw

Strong SW

INTERNAL HEXAGON

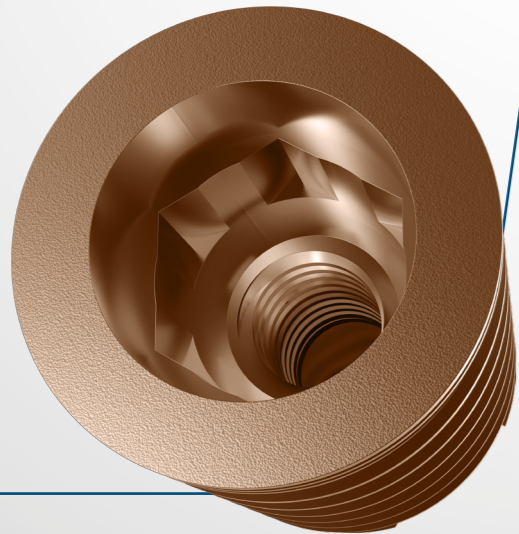
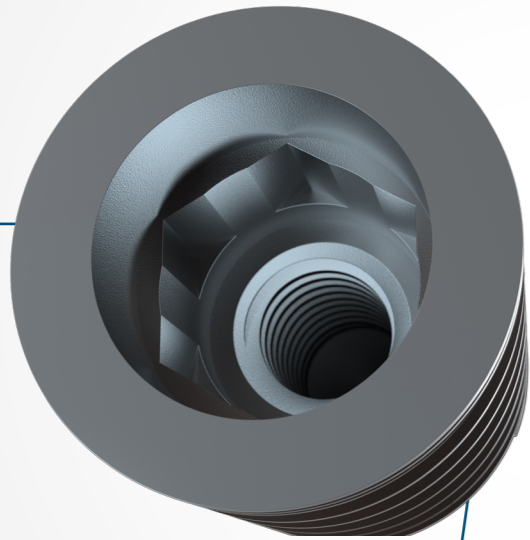

- › Indicated for immediate or late loading rehabilitation and for single or multiple implants.
- › It allows the installation in any type of bone, including post-extraction.
- › 3 key options for installation (contra-angle, ratchet and digital key).

INDICATIONS FOR CLINICAL USE:

- › 3.8 – Central, Lateral, canines and premolars
- › 4.5 – Premolars and Molars
- › 5.0 – Molars

› Bone level installation.

- › Speed of the Initial drills: 1.500 rpm.
- › Speed of the Drills 3.5 to 5.0mm: 800 rpm.
- › Speed of the Bone tap: 25 rpm*.
- › Insertion speed: 20 to 40 rpm.
- › Immediate loading: recommended torque from 45 to 80 N.cm.**
- › Late loading: maximum Torque 45 N.cm.

* The use of the Bone tap is optional in bone type I and II because it is a compressive implant, however the maximum torque must always be respected.

** Relative contraindication in patients with systemic or local problems and at professional's discretion.

DRILLING SEQUENCE GUIDE

		1500 rpm			800 rpm				25 rpm				
		FRLD	FHD	FRWD	FRWD	FCWD	FRWD	FRWD	CMRIW	CMRIW	CMRIW	CMRIW	CMRIW
PLAT. (mm)	DIAM. (mm)	2020 Ø 2.0	2015 Ø 2.0	35 Ø 3.05	38 Ø 3.3	41 Ø 4.1	45 Ø 4.0	50 Ø 4.25	35 Ø 3.5	37 Ø 3.75	38 Ø 3.8	45 Ø 4.5	50 Ø 5.0
Strong SW	3,8	•	•	•	•							•	
Strong SW Plus	4,5	•	•	•	•		•					•	
	5	•	•	•	•		•	•					•

• The use of the bone tap is optional in bone type I and II because it is a compressive implant, however the maximum torque must always be respected.

Technical measures

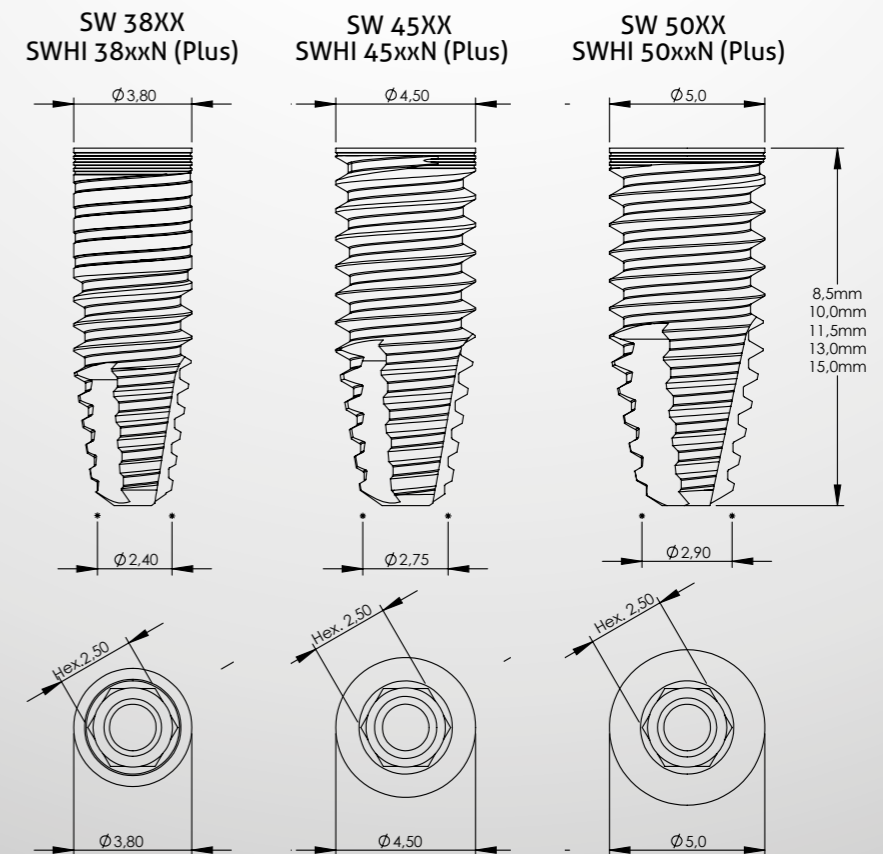

INTERNAL HEX PROSTHETIC SEQUENCE

DIRECT SEQUENCE OVER THE IMPLANT

Single restorations

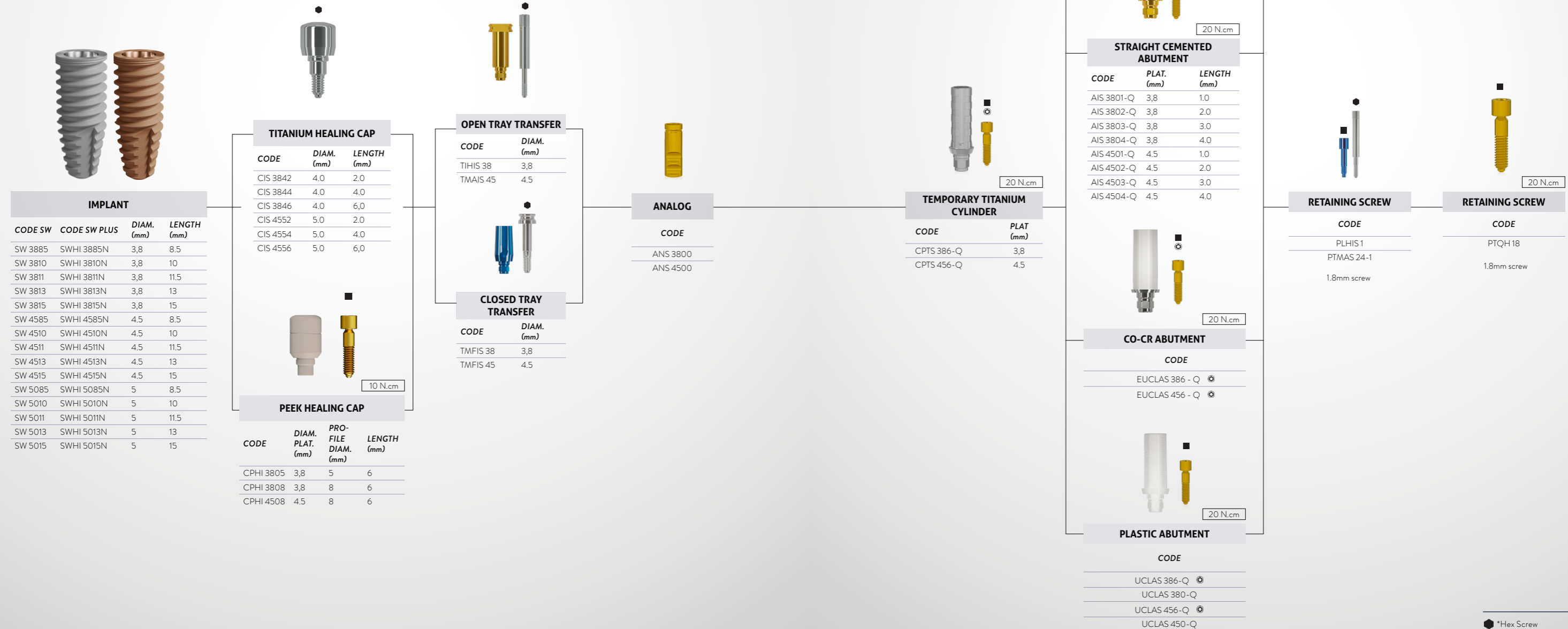

INTERNAL HEX.

* Check the availability of the products in your region.

- *Hex Screw
- ⊙ *Anti-Rotational Component
- *Square Screw
- ⊕ *Abutment Screw

INTERNAL HEX PROSTHETIC SEQUENCE

MULTI-UNIT ABUTMENT

MULTIPLE SCREW RETAINED RESTORATIONS

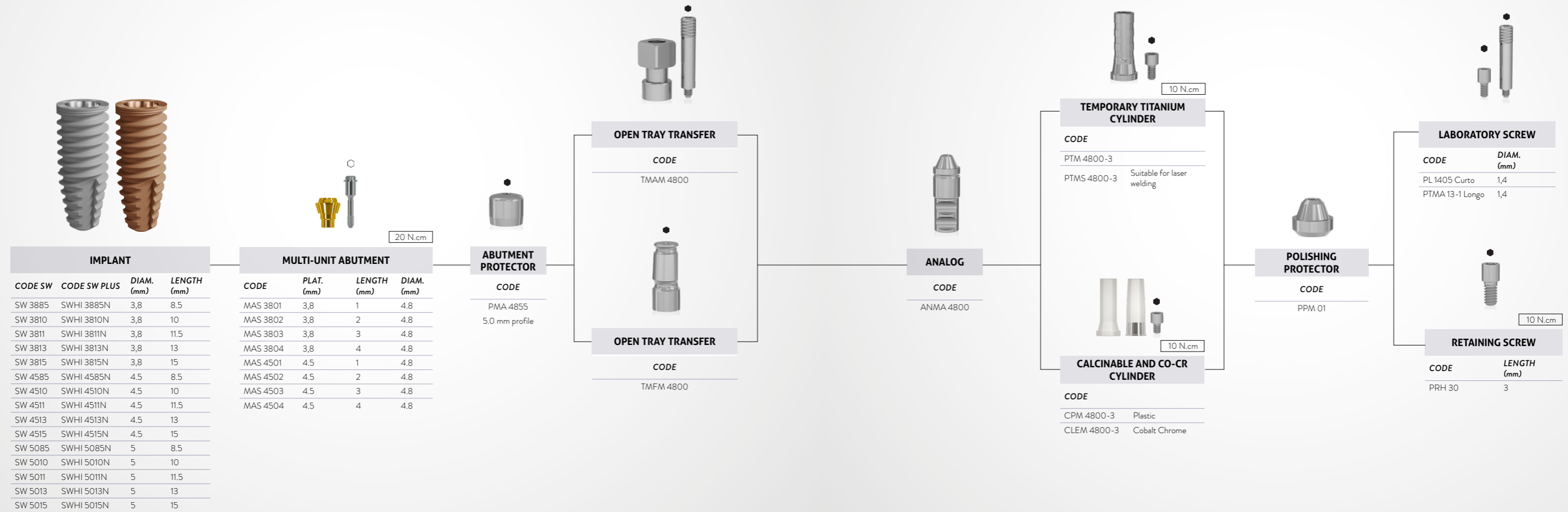

INTERNAL HEX.

* Check the availability of the products in your region.

- *Hex Screw
- ⊙ *Anti-Rotational Component
- *Square Screw
- ⬡ *Abutment Screw

INTERNAL HEX PROSTHETIC SEQUENCE

CONICAL ABUTMENT

SINGLE/MULTIPLE SCREW RETAINED RESTORATIONS

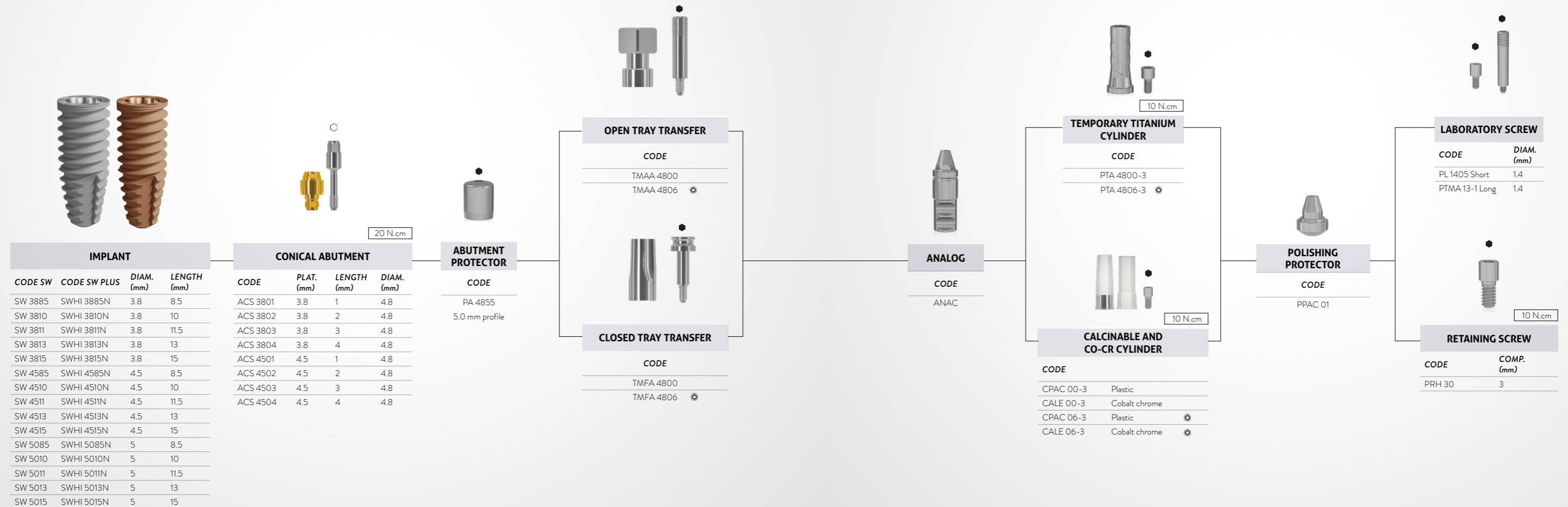

INTERNAL HEX.

* Check the availability of the products in your region.

- *Hex Screw
- ⊙ *Anti-Rotational Component
- *Square Screw
- ⬡ *Abutment Screw

INTERNAL HEX PROSTHETIC SEQUENCE

OVERDENTURE SOLUTIONS BAR-CLIP ATTACHMENT

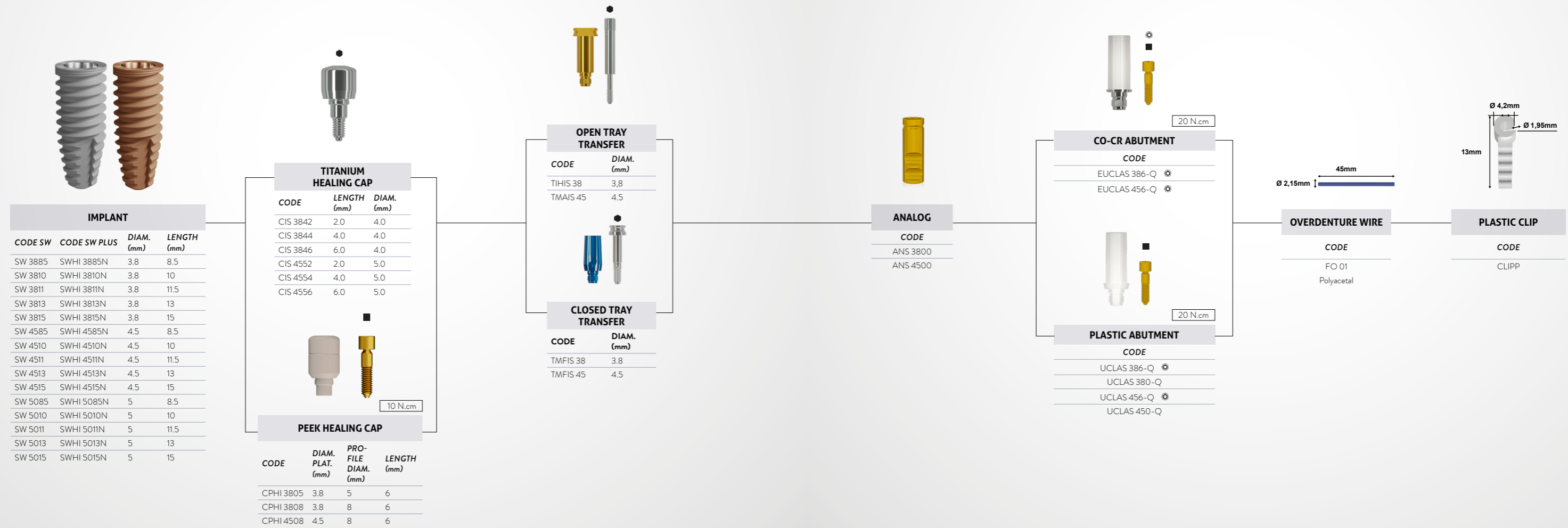

INTERNAL HEX.

* Check the availability of the products in your region.

- *Hex Screw
- ⊙ *Anti-Rotational Component
- *Square Screw
- ⊕ *Abutment Screw

INTERNAL HEX PROSTHETIC SEQUENCE

OVERDENTURE SOLUTIONS MULTI-UNIT + BAR-CLIP RESTORATIONS

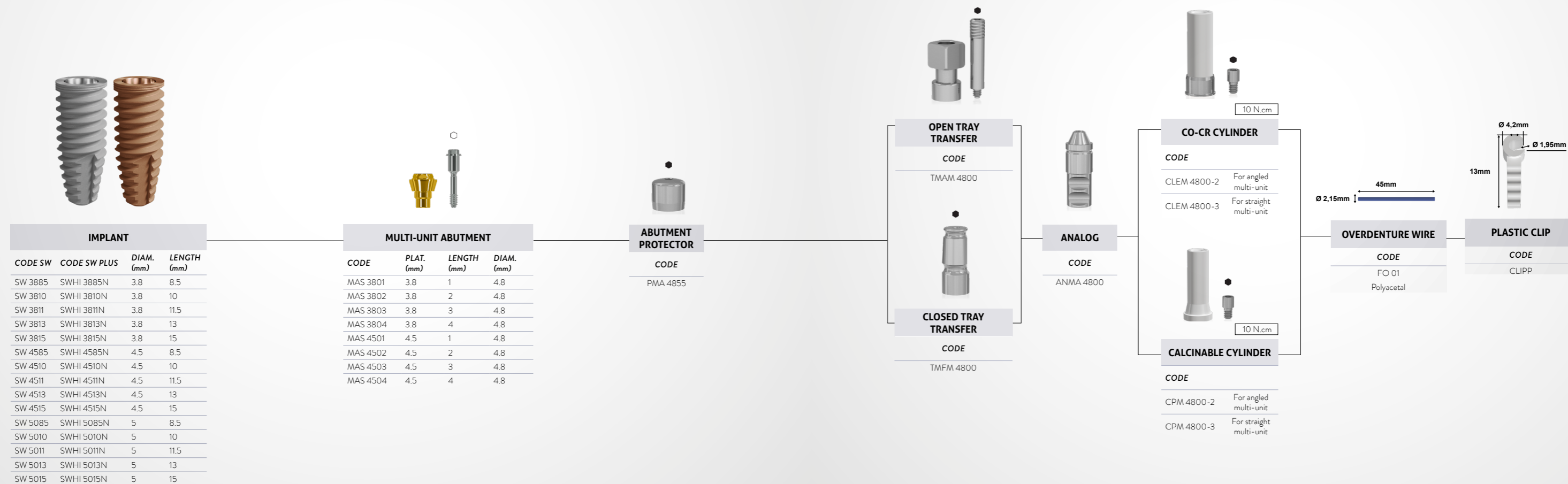

INTERNAL HEX.

* Check the availability of the products in your region.

- *Hex Screw
- ⊙ *Anti-Rotational Component
- *Square Screw
- ⬡ *Abutment Screw

Strong SW

16° MORSE TAPER

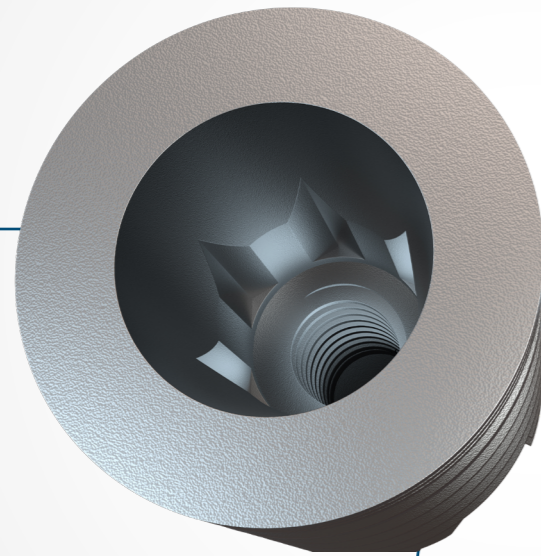

- › Indicated for all bone types and for rehabilitation with immediate or late loading.
- › Also recommended for small mesiodistal spaces (lower incisors and upper lateral).
- › It allows the installation in any type of bone, including post-extraction.
- › Single or multiple implants.
- › 3 key options for installation (contra-angle, ratchet and digital key).
- › For installation at bone level, purchase the TIMC implant cover.

INDICATIONS FOR CLINICAL USE:

- › 3.5 – Central incisors and Lateral
- › 3.75 – Central and lateral superiors, canines and premolars
- › 4.5 – Premolars and Molars
- › 5.0 – Molars

› 1.5 mm infra-bone installation.

- › Internal angle of 16°.
- › Speed of the Initial drills: 1.500 rpm.
- › Speed of the Drills 3.5 to 5.0mm: 800 rpm.
- › Speed of the Bone tap: 25 rpm*.
- › Insertion speed: 20 to 40 rpm
- › Immediate loading: recommended torque from 45 to 80 N.cm.**
- › Late loading: maximum Torque 45 N.cm.

* The use of the bone tap is optional in bone type I and II because it is a compressive implant, however the maximum torque must always be respected.

** Relative contraindication in patients with systemic or local problems and at professional's discretion.

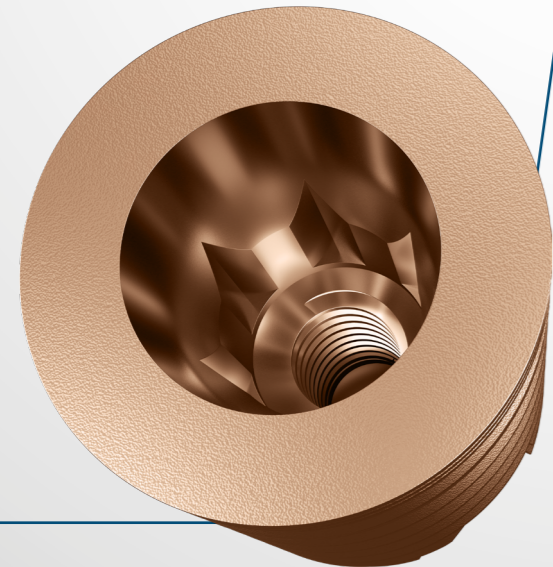

DRILLING SEQUENCE GUIDE

		1500 rpm			800 rpm				25 rpm				
PLAT. (mm)	DIAM. (mm)	FRLD 2020 Ø 2.0	FHD 2015 Ø 2.0	FRWD 35 Ø 3.05	FRWD 38 Ø 3.3	FCWD 41 Ø 4.1	FRWD 45 Ø 4.0	FRWD 50 Ø 4.25	CMRIW 35 Ø 3.5	CMRIW 37 Ø 3.75	CMRIW 38 Ø 3.8	CMRIW 45 Ø 4.5	CMRIW 50 Ø 5.0
3.5	3.5	•	•	•					•				
3,8	3,8	•	•	•	•						•		
4.5	4.5	•	•	•	•		•					•	
5	5	•	•	•	•		•	•					•



• The use of the bone tap is optional in bone type I and II because it is a compressive implant, however the maximum torque must always be respected.

Technical measures

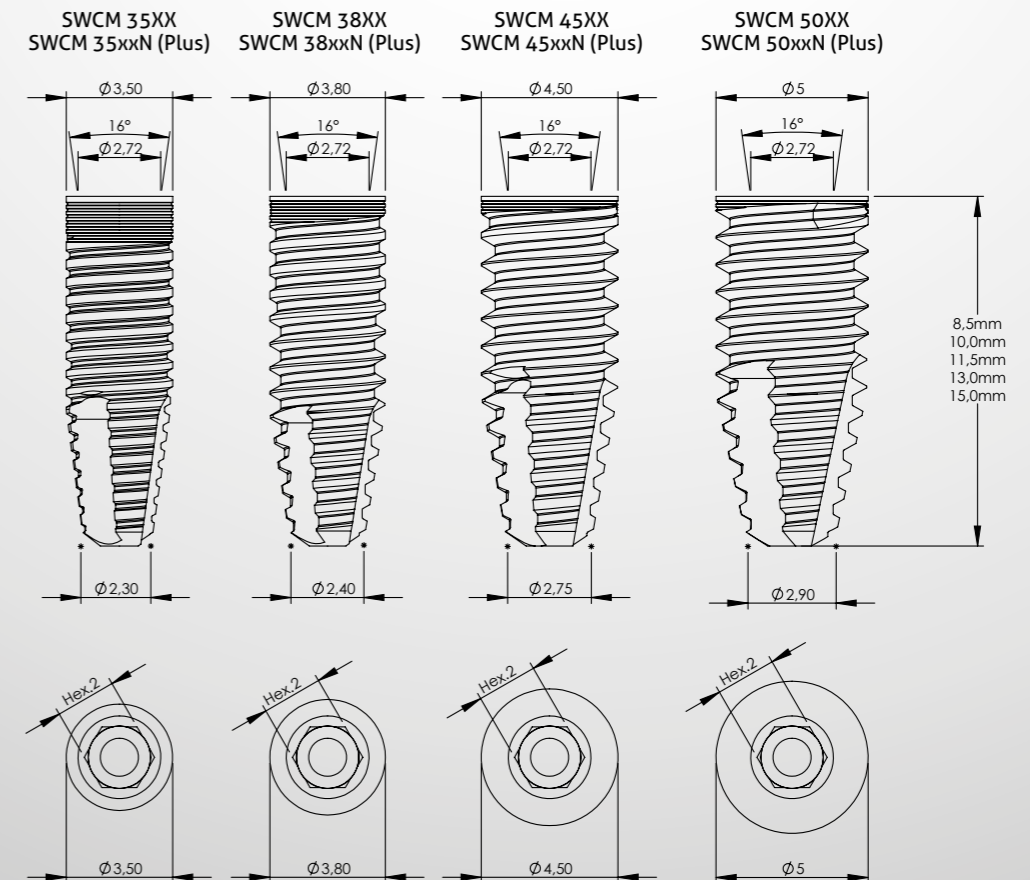

16° MORSE TAPER PROSTHETIC SEQUENCE

DIRECT SEQUENCE OVER THE IMPLANT

Single restorations

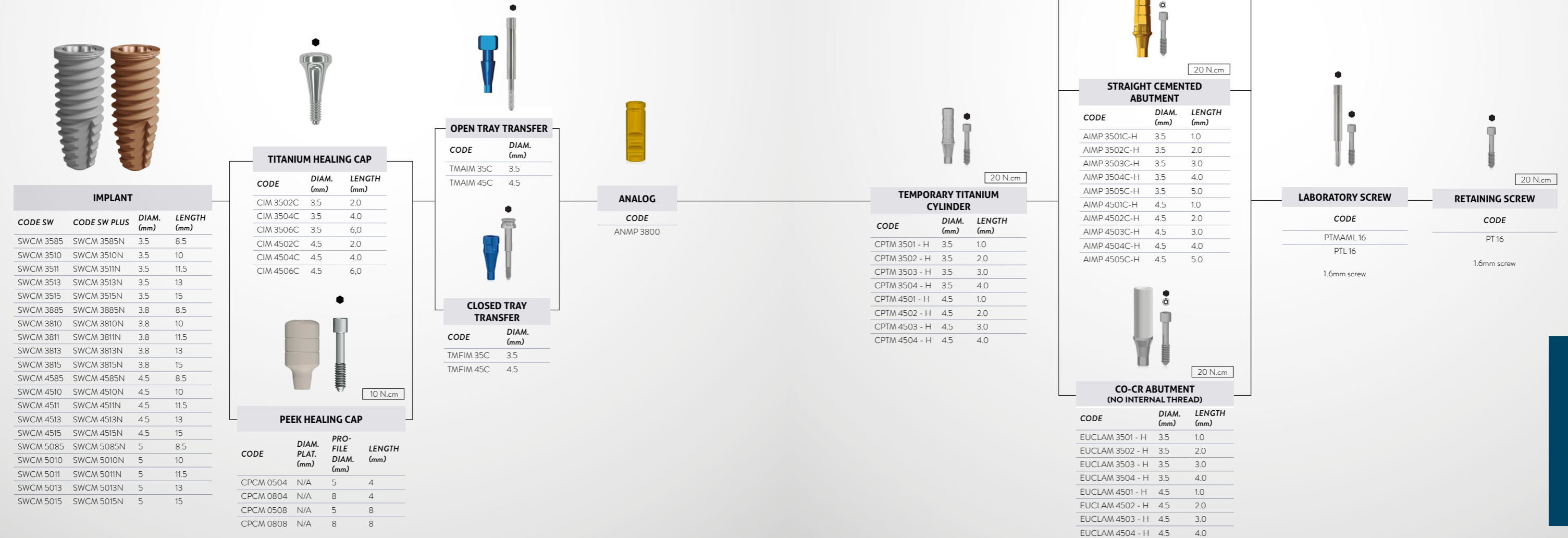

* Check the availability of the products in your region.

- *Hex Screw
- ⊙ *Anti-Rotational Component
- *Square Screw
- ⬡ *Abutment Screw

16° MORSE TAPER PROSTHETIC SEQUENCE

UNIVERSAL ABUTMENT - PRE-MADE POSTS

CEMENTED RETAINED RESTORATIONS

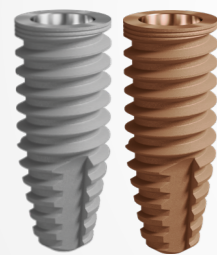

IMPLANT

CODE SW	CODE SW PLUS	DIAM. (mm)	LENGTH (mm)
SWCM 3585	SWCM 3585N	3.5	8.5
SWCM 3510	SWCM 3510N	3.5	10
SWCM 3511	SWCM 3511N	3.5	11.5
SWCM 3513	SWCM 3513N	3.5	13
SWCM 3515	SWCM 3515N	3.5	15
SWCM 3885	SWCM 3885N	3.8	8.5
SWCM 3810	SWCM 3810N	3.8	10
SWCM 3811	SWCM 3811N	3.8	11.5
SWCM 3813	SWCM 3813N	3.8	13
SWCM 3815	SWCM 3815N	3.8	15
SWCM 4585	SWCM 4585N	4.5	8.5
SWCM 4510	SWCM 4510N	4.5	10
SWCM 4511	SWCM 4511N	4.5	11.5
SWCM 4513	SWCM 4513N	4.5	13
SWCM 4515	SWCM 4515N	4.5	15
SWCM 5085	SWCM 5085N	5	8.5
SWCM 5010	SWCM 5010N	5	10
SWCM 5011	SWCM 5011N	5	11.5
SWCM 5013	SWCM 5013N	5	13
SWCM 5015	SWCM 5015N	5	15

TITANIUM HEALING CAP

CODE	DIAM. (mm)	LENGTH (mm)
CIM 3502C	3.5	2.0
CIM 3504C	3.5	4.0
CIM 3506C	3.5	6.0
CIM 4502C	4.5	2.0
CIM 4504C	4.5	4.0
CIM 4506C	4.5	6.0

PEEK HEALING CAP

CODE	DIAM. PLAT. (mm)	PRO-FILE DIAM. (mm)	LENGTH (mm)
CPCM 0504	N/A	5	4
CPCM 0804	N/A	8	4
CPCM 0508	N/A	5	8
CPCM 0808	N/A	8	8



20 N.cm

CEMENTED UNIVERSAL ABUTMENT

CODE	DIAM. (mm)	CEMENTATION LENGTH (mm)	TRANSMUCOSAL LENGTH (mm)
AIM 33401C	3.3	4	1
AIM 33402C	3.3	4	2
AIM 33403C	3.3	4	3
AIM 33404C	3.3	4	4
AIM 33405C	3.3	4	5
AIM 33601C	3.3	6	1
AIM 33602C	3.3	6	2
AIM 33603C	3.3	6	3
AIM 33604C	3.3	6	4
AIM 33605C	3.3	6	5
AIM 45401C	4.5	4	1
AIM 45402C	4.5	4	2
AIM 45403C	4.5	4	3
AIM 45404C	4.5	4	4
AIM 45405C	4.5	4	5
AIM 45601C	4.5	6	1
AIM 45602C	4.5	6	2
AIM 45603C	4.5	6	3
AIM 45604C	4.5	6	4
AIM 45605C	4.5	6	5



10 N.cm

17° ANGLED CEMENTED UNIVERSAL ABUTMENT

CODE	DIAM. (mm)	CEMENTATION LENGTH (mm)	TRANSMUCOSAL LENGTH (mm)
AAIM 331741C	3.3	1,5	4
AAIM 331742C	3.3	2,5	4
AAIM 331743C	3.3	3,5	4
AAIM 331761C	3.3	1,5	6
AAIM 331762C	3.3	2,5	6
AAIM 331763C	3.3	3,5	6
AAIM 451741C	4.5	1,5	4
AAIM 451742C	4.5	2,5	4
AAIM 451743C	4.5	3,5	4
AAIM 451761C	4.5	1,5	6
AAIM 451762C	4.5	2,5	6
AAIM 451763C	4.5	3,5	6



POLYACETAL TRANSFER

CODE	DIAM. (mm)	LENGTH (mm)
TSIT 3340	3.3	4.0
TSIT 3360	3.3	6.0
TSIT 4540	4.5	4.0
TSIT 4560	4.5	6.0



TITANIUM GRAU 5 ANALOG

CODE	DIAM. (mm)	LENGTH (mm)
ASIT 3340	3.3	4.0
ASIT 3360	3.3	6.0
ASIT 4540	4.5	4.0
ASIT 4560	4.5	6.0



CALCINABLE POLYACETAL CYLINDER

CODE	DIAM. (mm)	LENGTH (mm)
CCSIT 3340	3.3	4.0
CCSIT 3360	3.3	6.0
CCSIT 4540	4.5	4.0
CCSIT 4560	4.5	6.0



TEMPORARY ACRYLIC CYLINDER

CODE	DIAM. (mm)	LENGTH (mm)
CPSIT 3340	3.3	4.0
CPSIT 3360	3.3	6.0
CPSIT 4540	4.5	4.0
CPSIT 4560	4.5	6.0

* Check the availability of the products in your region.

- *Hex Screw
- ⊙ *Anti-Rotational Component
- *Square Screw
- ⬡ *Abutment Screw

16° MORSE TAPER PROSTHETIC SEQUENCE

MULTI-UNIT ABUTMENT

MULTIPLE SCREW RETAINED RESTORATIONS

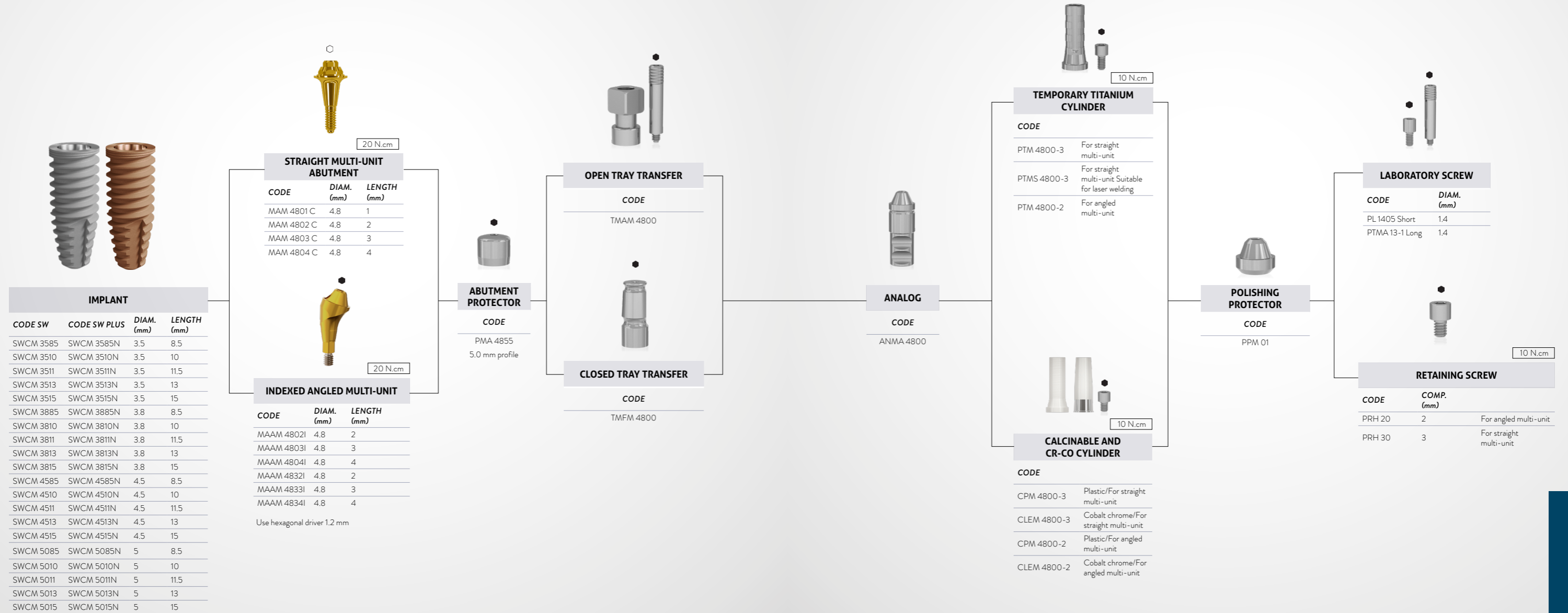

* Check the availability of the products in your region.

- *Hex Screw
- ⊙ *Anti-Rotational Component
- *Square Screw
- ⬡ *Abutment Screw

16° MORSE TAPER PROSTHETIC SEQUENCE

MICRO MULTI-UNIT ABUTMENT

MULTIPLE SCREW RETAINED RESTORATIONS

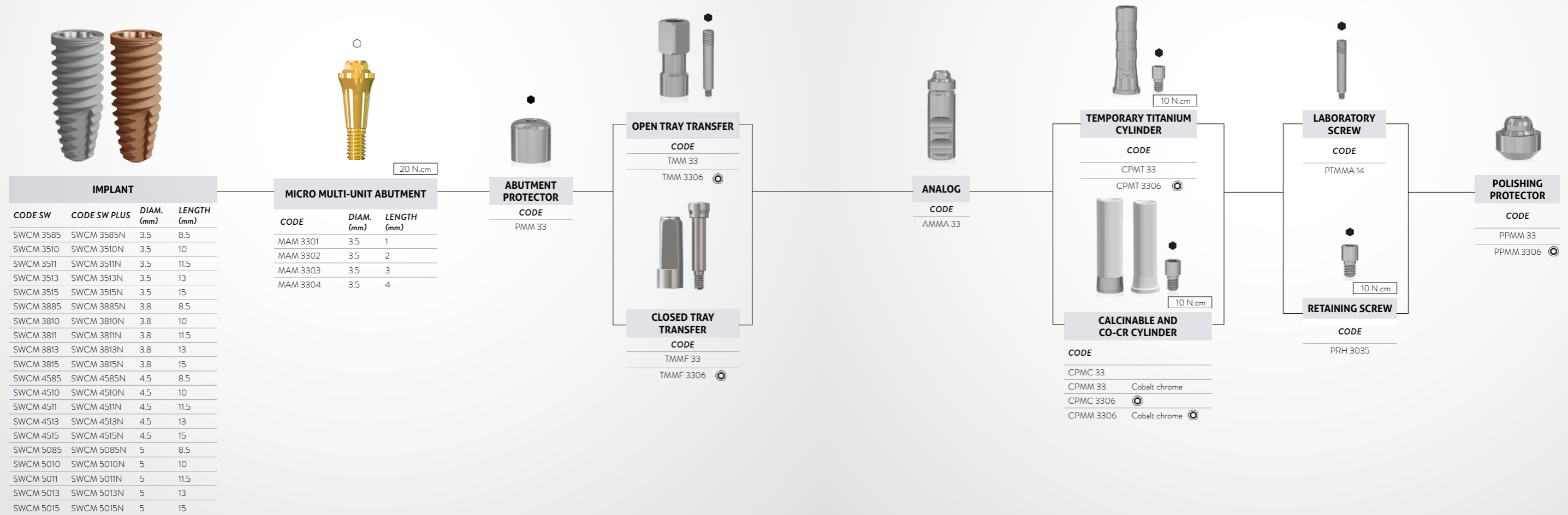

IMPLANT			
CODE SW	CODE SW PLUS	DIAM. (mm)	LENGTH (mm)
SWCM 3585	SWCM 3585N	3.5	8.5
SWCM 3510	SWCM 3510N	3.5	10
SWCM 3511	SWCM 3511N	3.5	11.5
SWCM 3513	SWCM 3513N	3.5	13
SWCM 3515	SWCM 3515N	3.5	15
SWCM 3885	SWCM 3885N	3.8	8.5
SWCM 3810	SWCM 3810N	3.8	10
SWCM 3811	SWCM 3811N	3.8	11.5
SWCM 3813	SWCM 3813N	3.8	13
SWCM 3815	SWCM 3815N	3.8	15
SWCM 4585	SWCM 4585N	4.5	8.5
SWCM 4510	SWCM 4510N	4.5	10
SWCM 4511	SWCM 4511N	4.5	11.5
SWCM 4513	SWCM 4513N	4.5	13
SWCM 4515	SWCM 4515N	4.5	15
SWCM 5085	SWCM 5085N	5	8.5
SWCM 5010	SWCM 5010N	5	10
SWCM 5011	SWCM 5011N	5	11.5
SWCM 5013	SWCM 5013N	5	13
SWCM 5015	SWCM 5015N	5	15

MICRO MULTI-UNIT ABUTMENT		
CODE	DIAM. (mm)	LENGTH (mm)
MAM 3301	3.5	1
MAM 3302	3.5	2
MAM 3303	3.5	3
MAM 3304	3.5	4

ABUTMENT PROTECTOR
CODE
PMM 33

OPEN TRAY TRANSFER
CODE
TMM 33
TMM 3306

CLOSED TRAY TRANSFER
CODE
TMMF 33
TMMF 3306

ANALOG
CODE
AMMA 33

TEMPORARY TITANIUM CYLINDER
CODE
CPMT 33
CPMT 3306

CALCINABLE AND CO-CR CYLINDER
CODE
CPMC 33
CPMM 33
CPMC 3306
CPMM 3306

LABORATORY SCREW
CODE
PTMMA 14

RETAINING SCREW
CODE
PRH 3035

POLISHING PROTECTOR
CODE
PMM 33
PPMM 3306

* Check the availability of the products in your region.

- *Hex Screw
- ⊙ *Anti-Rotational Component
- *Square Screw
- ⬡ *Abutment Screw

16° MORSE TAPER PROSTHETIC SEQUENCE

MULTIFUNCTIONAL ABUTMENT

SINGLE/MULTIPLE SCREW RETAINED RESTORATIONS

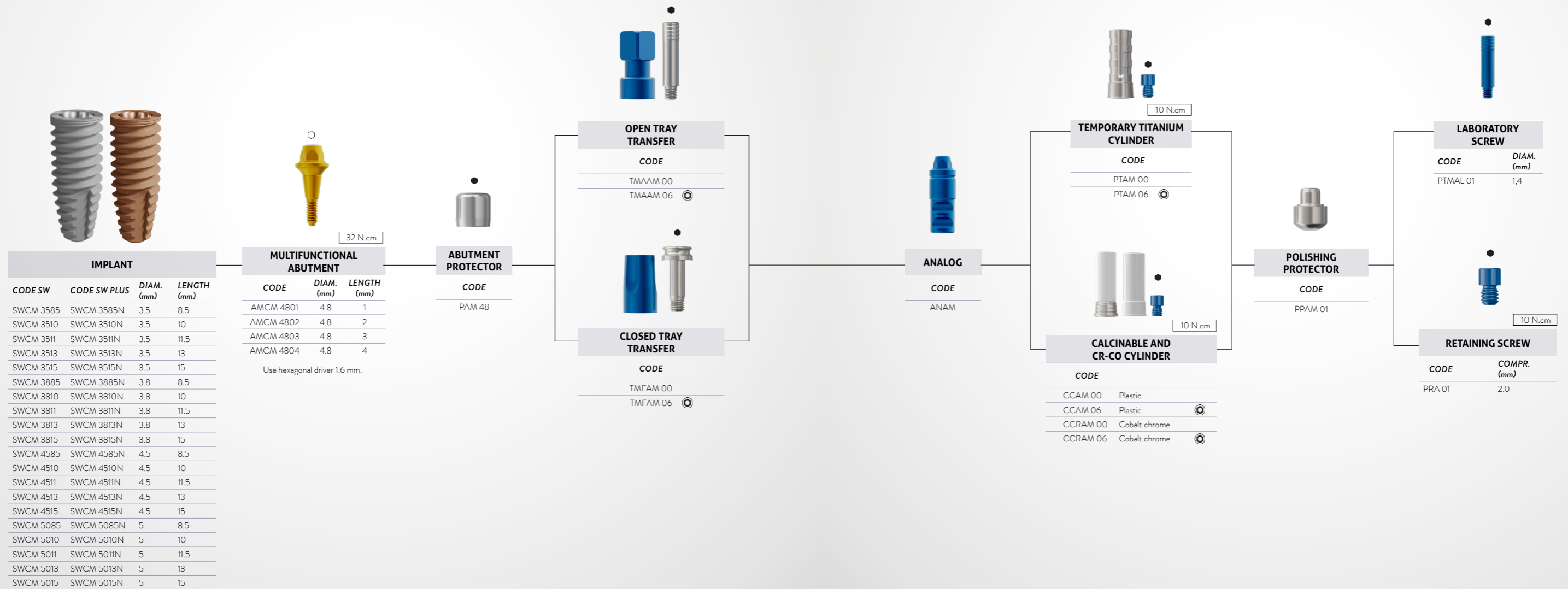

* Check the availability of the products in your region.

- *Hex Screw
- ⊙ *Anti-Rotational Component
- *Square Screw
- ⬡ *Abutment Screw

16° MORSE TAPER PROSTHETIC SEQUENCE

CONICAL ABUTMENT

SINGLE/MULTIPLE SCREW RETAINED RESTORATIONS

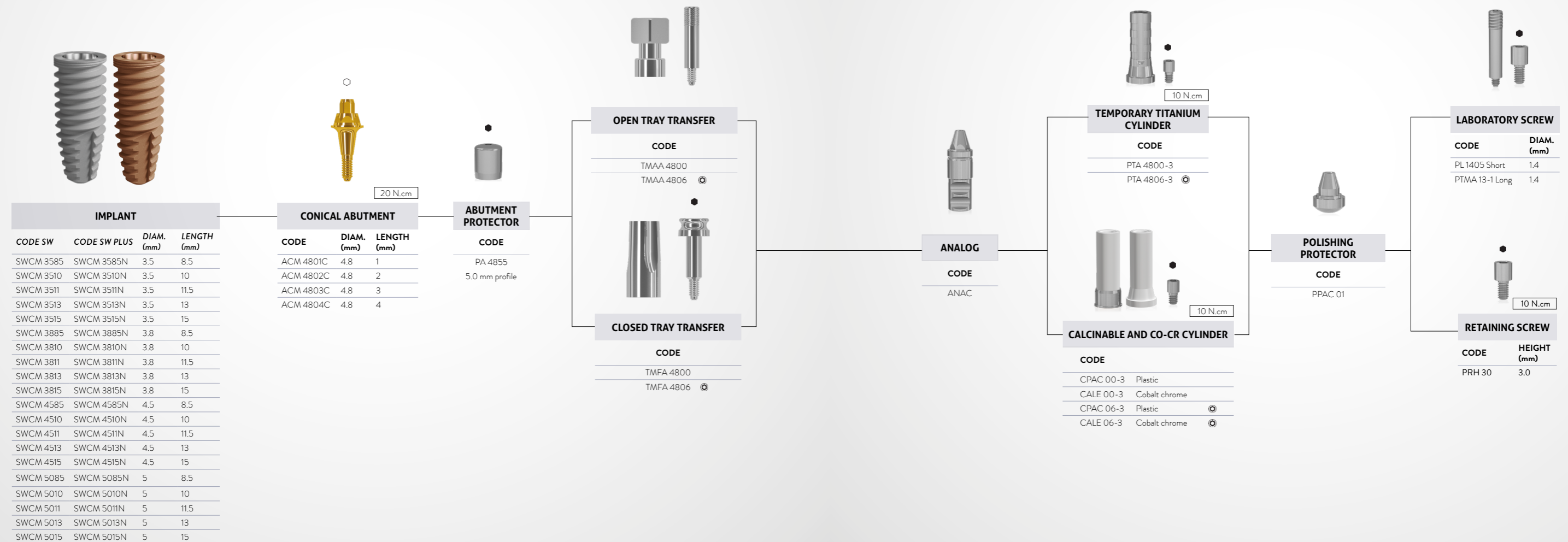

* Check the availability of the products in your region.

- *Hex Screw
- *Anti-Rotational Component
- *Square Screw
- *Abutment Screw

16° MORSE TAPER PROSTHETIC SEQUENCE

OVERDENTURE SOLUTIONS MULTI-UNIT + BAR-CLIP RESTORATIONS

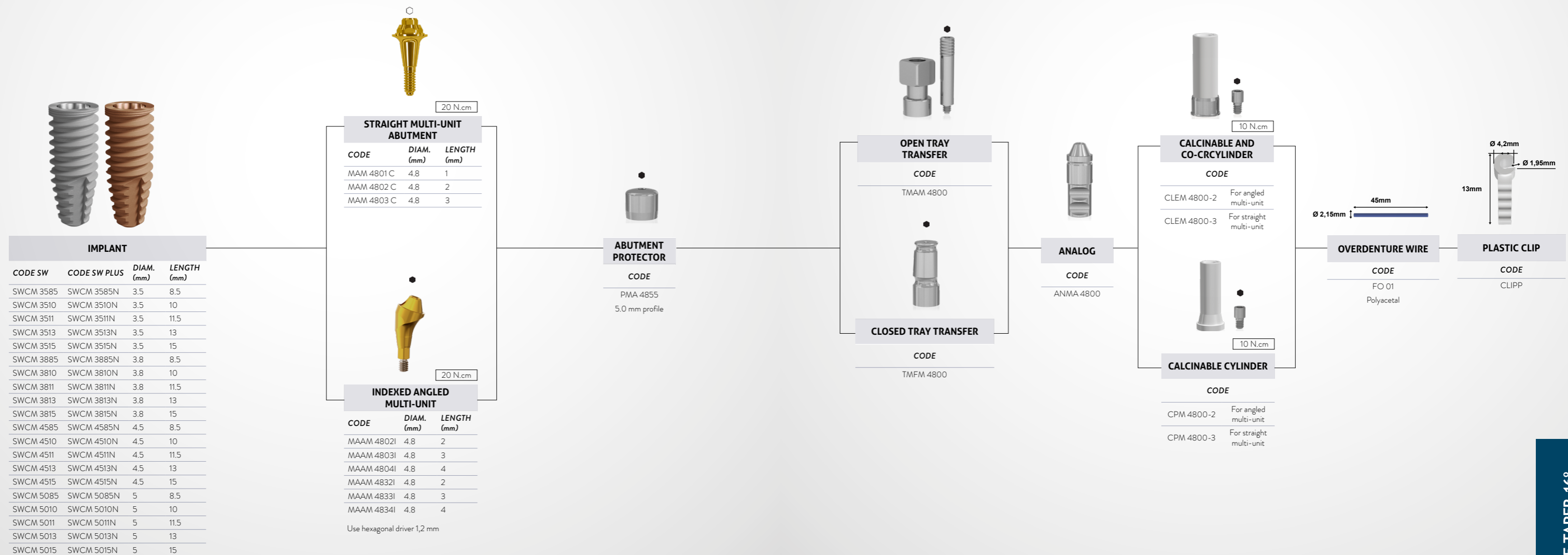

* Check the availability of the products in your region.

- *Hex Screw
- ⊙ *Anti-Rotational Component
- *Square Screw
- ⬡ *Abutment Screw

Strong swc

11.5° MORSE TAPER

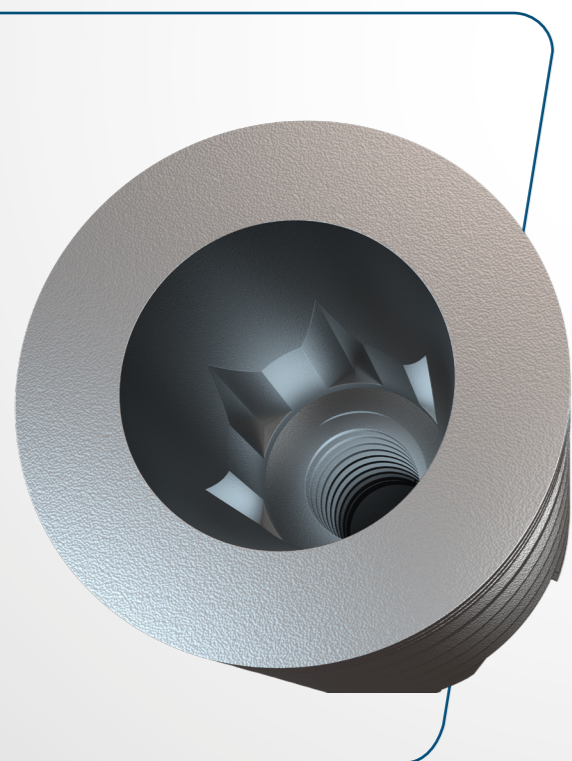

- › Indicated for all bone types and for rehabilitation with immediate or late loading.
- › Also recommended for small mesiodistal spaces (lower incisors and upper lateral).
- › It allows the installation in any type of bone, including post-extraction.
- › Single or multiple implants.
- › 3 key options for installation (contra-angle, ratchet and digital key).
- › For installation at bone level, purchase the TIMU 0212 implant cover.
- › Interchangeable components with Unitite Prime line.

INDICATIONS FOR CLINICAL USE:

- › 3.5 mm – Central incisors and Lateral
- › 3.8 mm – Central and lateral superiors, canines and premolars
- › 4.5 mm – Premolars and Molars
- › 5.0 mm – Molars

› 1.5 mm infra-bone installation.

- › Internal angle of 11.5°.
- › Speed of the Initial drills: 1.500 rpm.
- › Speed of the Drills 3.5 to 5.0mm: 800 rpm.
- › Speed of the Bone tap: 25 rpm*.
- › Insertion speed: 20 to 40 rpm
- › Immediate loading: recommended torque from 45 to 80 N.cm.**
- › Late loading: maximum Torque 45 N.cm.

* The use of the bone tap is optional in bone type I and II because it is a compressive implant, however the maximum torque must always be respected.

** Relative contraindication in patients with systemic or local problems and at professional's discretion.

SEQUÊNCIA DE FRESAS

		1500 rpm			800 rpm				25 rpm				
PLAT. (mm)	DIAM. (mm)	FRLD 2020 Ø 2.0	FHD 2015 Ø 2.0	FRWD 35 Ø 3.05	FRWD 38 Ø 3.3	FCWD 41 Ø 4.1	FRWD 45 Ø 4.0	FRWD 50 Ø 4.25	CMRIW 35 Ø 3.5	CMRIW 37 Ø 3.75	CMRIW 38 Ø 3.8	CMRIW 45 Ø 4.5	CMRIW 50 Ø 5.0
 Strong swc	3.5	•	•	•					•				
	3.8	•	•	•	•						•		
	4.5	•	•	•	•		•					•	
	5	•	•	•	•		•	•					•

• The use of the bone tap is optional in bone type I and II because it is a compressive implant, however the maximum torque must always be respected.

Technical measures

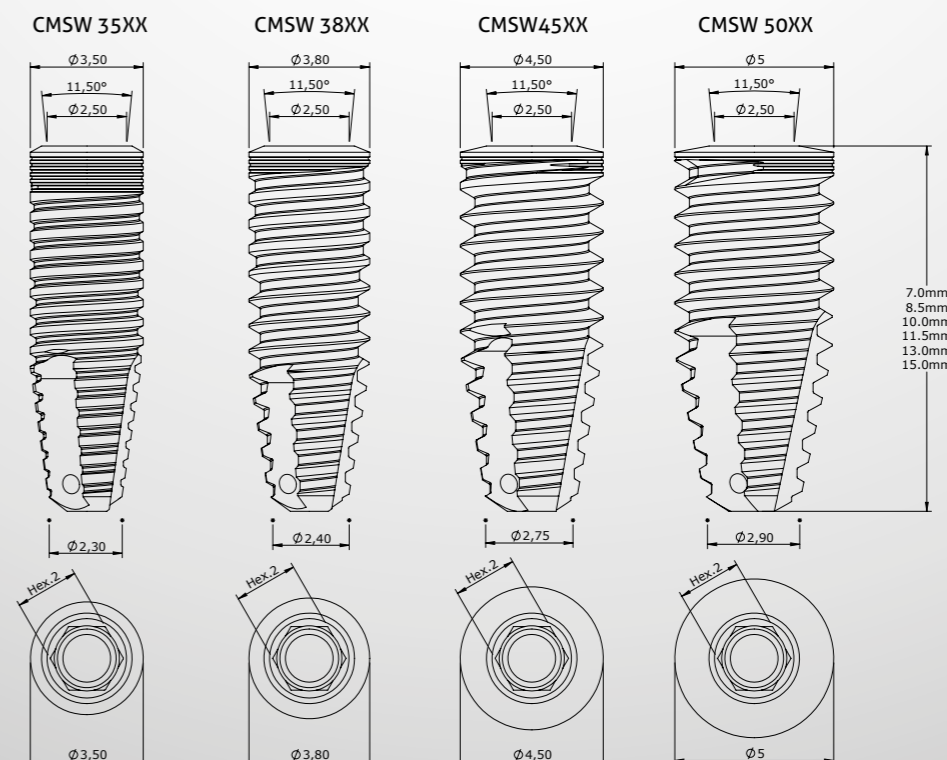

11.5° MORSE TAPER PROSTHETIC SEQUENCE

DIRECT SEQUENCE OVER THE IMPLANT

Single restorations

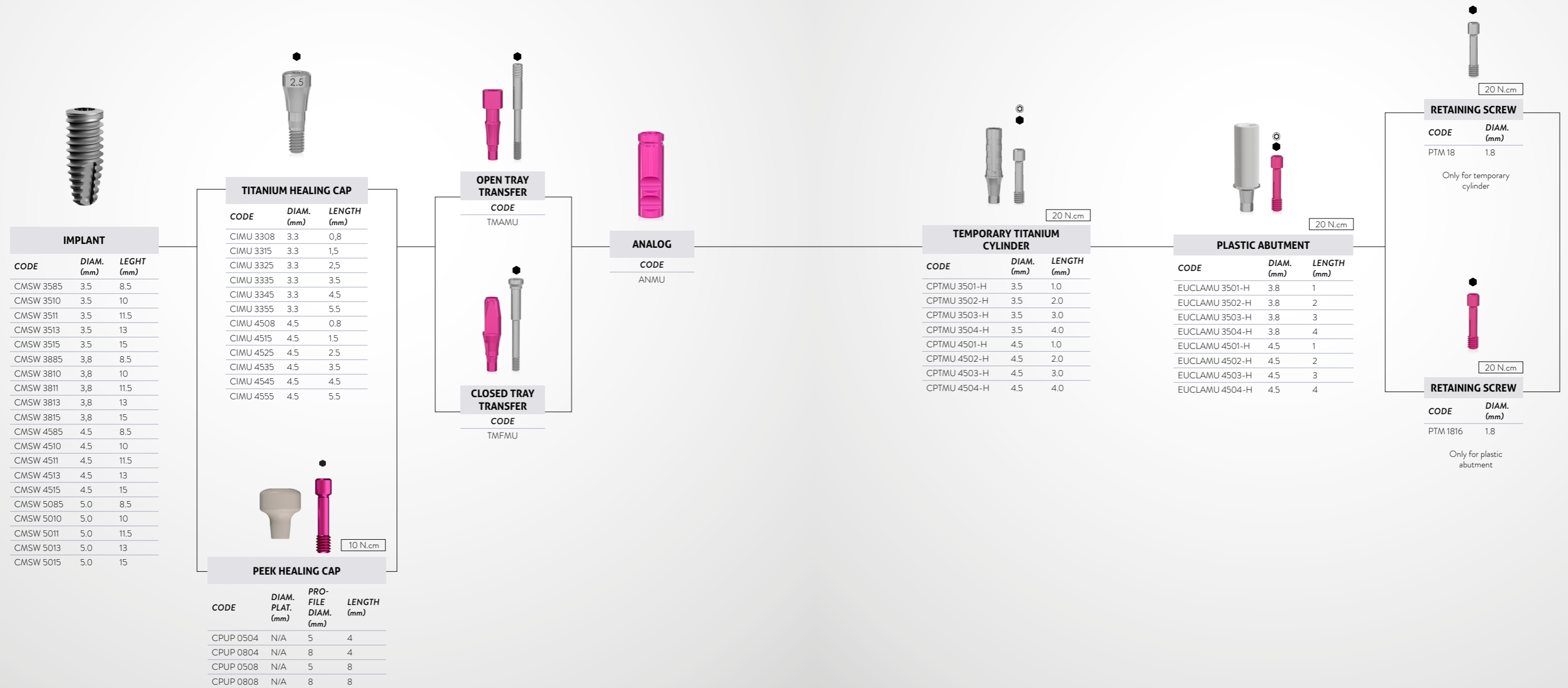

* Check the availability of the products in your region.

- *Hex Screw
- ⊙ *Anti-Rotational Component
- *Square Screw
- ⬡ *Abutment Screw
- ⊙ *Rotational component

11.5° MORSE TAPER PROSTHETIC SEQUENCE

UNIVERSAL ABUTMENT PRE-MADE POSTS

CEMENTED RETAINED RESTORATIONS



20 N.cm

ONE-PIECE STRAIGHT UNIVERSAL ABUTMENT			
CODE	DIAM. (mm)	CEMENTATION LENGTH(mm)	TRANSMUCOSAL LENGTH (mm)
AISIT 334008	3.3	4	0.8
AISIT 334015	3.3	4	1.5
AISIT 334025	3.3	4	2.5
AISIT 334035	3.3	4	3.5
AISIT 334045	3.3	4	4.5
AISIT 334055	3.3	4	5.5
AISIT 336008	3.3	6	0.8
AISIT 336015	3.3	6	1.5
AISIT 336025	3.3	6	2.5
AISIT 336035	3.3	6	3.5
AISIT 336045	3.3	6	4.5
AISIT 336055	3.3	6	5.5
AISIT 454008	4.5	4	0.8
AISIT 454015	4.5	4	1.5
AISIT 454025	4.5	4	2.5
AISIT 454035	4.5	4	3.5
AISIT 454045	4.5	4	4.5
AISIT 454055	4.5	4	5.5
AISIT 456008	4.5	6	0.8
AISIT 456015	4.5	6	1.5
AISIT 456025	4.5	6	2.5
AISIT 456035	4.5	6	3.5
AISIT 456045	4.5	6	4.5
AISIT 456055	4.5	6	5.5



10 N.cm

TWO-PIECES STRAIGHT UNIVERSAL ABUTMENT			
CODE	DIAM. (mm)	CEMENTATION LENGTH(mm)	TRANSMUCOSAL LENGTH (mm)
APSIT 334008	3.3	4	0.8
APSIT 334015	3.3	4	1.5
APSIT 334025	3.3	4	2.5
APSIT 334035	3.3	4	3.5
APSIT 334045	3.3	4	4.5
APSIT 334055	3.3	4	5.5
APSIT 336008	3.3	6	0.8
APSIT 336015	3.3	6	1.5
APSIT 336025	3.3	6	2.5
APSIT 336035	3.3	6	3.5
APSIT 336045	3.3	6	4.5
APSIT 336055	3.3	6	5.5
APSIT 454008	4.5	4	0.8
APSIT 454015	4.5	4	1.5
APSIT 454025	4.5	4	2.5
APSIT 454035	4.5	4	3.5
APSIT 454045	4.5	4	4.5
APSIT 454055	4.5	4	5.5
APSIT 456008	4.5	6	0.8
APSIT 456015	4.5	6	1.5
APSIT 456025	4.5	6	2.5
APSIT 456035	4.5	6	3.5
APSIT 456045	4.5	6	4.5
APSIT 456055	4.5	6	5.5

Use hexagonal driver 0.9 mm



10 N.cm

ANGLED UNIVERSAL ABUTMENT					
CODE	DIAM. (mm)	ANG.	HIGHER TRANSMUCOSAL LENGTH (mm)	LOWER TRANSMUCOSAL LENGTH (mm)	CEMENTATION LENGTH(mm)
APASIT 341715	3.3	17°	2.6	1.5	4
APASIT 341725	3.3	17°	3.6	2.5	4
APASIT 341735	3.3	17°	4.6	3.5	4
APASIT 343015	3.3	30°	3.15	1.5	4
APASIT 343025	3.3	30°	4.15	2.5	4
APASIT 343035	3.3	30°	5.15	3.5	4
APASIT 361715	3.3	17°	2.6	1.5	6
APASIT 361725	3.3	17°	3.6	2.5	6
APASIT 361735	3.3	17°	4.6	3.5	6
APASIT 363015	3.3	30°	3.15	1.5	6
APASIT 363025	3.3	30°	4.15	2.5	6
APASIT 363035	3.3	30°	5.15	3.5	6
APASIT 441715	4.5	17°	3	1.5	4
APASIT 441725	4.5	17°	4	2.5	4
APASIT 441735	4.5	17°	5	3.5	4
APASIT 443015	4.5	30°	3.75	1.5	4
APASIT 443025	4.5	30°	4.75	2.5	4
APASIT 443035	4.5	30°	5.75	3.5	4
APASIT 461715	4.5	17°	3	1.5	6
APASIT 461725	4.5	17°	4	2.5	6
APASIT 461735	4.5	17°	5	3.5	6
APASIT 463015	4.5	30°	3.75	1.5	6
APASIT 463025	4.5	30°	4.75	2.5	6
APASIT 463035	4.5	30°	5.75	3.5	6

Use hexagonal driver 0.9 mm



TEMPORARY ACRYLIC CYLINDER

CODE	DIAM. (mm)	LENGTH (mm)
CPSIT 3340	3.3	4
CPSIT 3360	3.3	6
CPSIT 4540	4.5	4
CPSIT 4560	4.5	6



CALCIFIABLE POLYACETAL CYLINDER

CODE	DIAM. (mm)	LENGTH (mm)
CCSIT 3340	3.3	4
CCSIT 3360	3.3	6
CCSIT 4540	4.5	4
CCSIT 4560	4.5	6



POLYACETAL IMPRESSION TRANSFER

CODE	DIAM. (mm)	LENGTH (mm)
TSIT 3340	3.3	4
TSIT 3360	3.3	6
TSIT 4540	4.5	4



ANALOG

CODE	DIAM. (mm)	LENGTH (mm)
ASIT 3340	3.3	4
ASIT 3360	3.3	6
ASIT 4540	4.5	4
ASIT 4560	4.5	6



TITANIUM HEALING CAP

CODE	DIAM. (mm)	LENGTH (mm)
CIMU 3308	3.3	0.8
CIMU 3315	3.3	1.5
CIMU 3325	3.3	2.5
CIMU 3335	3.3	3.5
CIMU 3345	3.3	4.5
CIMU 3355	3.3	5.5
CIMU 4508	4.5	0.8
CIMU 4515	4.5	1.5
CIMU 4525	4.5	2.5
CIMU 4535	4.5	3.5
CIMU 4545	4.5	4.5
CIMU 4555	4.5	5.5



10 N.cm

PEEK HEALING CAP

CODE	DIAM. PLAT. (mm)	PRO-FILE DIAM. (mm)	LEN-GTH (mm)
CPUP 0504	N/A	5	4
CPUP 0804	N/A	8	4
CPUP 0508	N/A	5	8
CPUP 0808	N/A	8	8

IMPLANT

CODE	DIAM. (mm)	LENGTH (mm)
CMSW 3585	3.5	8.5
CMSW 3510	3.5	10
CMSW 3511	3.5	11.5
CMSW 3513	3.5	13
CMSW 3515	3.5	15
CMSW 3885	3.8	8.5
CMSW 3810	3.8	10
CMSW 3811	3.8	11.5
CMSW 3813	3.8	13
CMSW 3815	3.8	15
CMSW 4585	4.5	8.5
CMSW 4510	4.5	10
CMSW 4511	4.5	11.5
CMSW 4513	4.5	13
CMSW 4515	4.5	15
CMSW 5085	5.0	8.5
CMSW 5010	5.0	10
CMSW 5011	5.0	11.5
CMSW 5013	5.0	13
CMSW 5015	5.0	15

- *Hex Screw
- ⊙ *Anti-Rotational Component
- *Square Screw
- ⊕ *Abutment Screw
- ⊙ *Rotational component

* Check the availability of the products in your region.

11.5° MORSE TAPER PROSTHETIC SEQUENCE

MULTIFUNCTIONAL ABUTMENT

SINGLE/MULTIPLE SCREW RETAINED RESTORATIONS

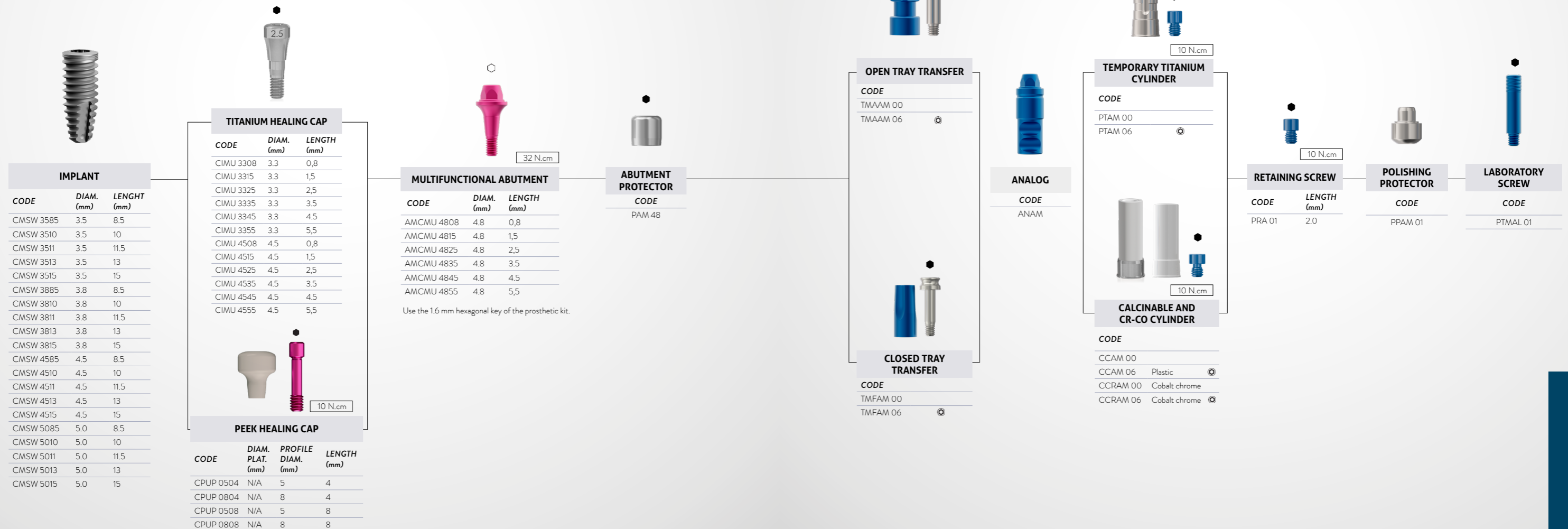

MORSE TAPER 11.5°

* Check the availability of the products in your region.

- *Hex Screw
- ⊙ *Anti-Rotational Component
- *Square Screw
- ⬡ *Abutment Screw
- ⊙ *Rotational component

11.5° MORSE TAPER PROSTHETIC SEQUENCE

CONICAL ABUTMENT

Single / Multiple screw retained restorations

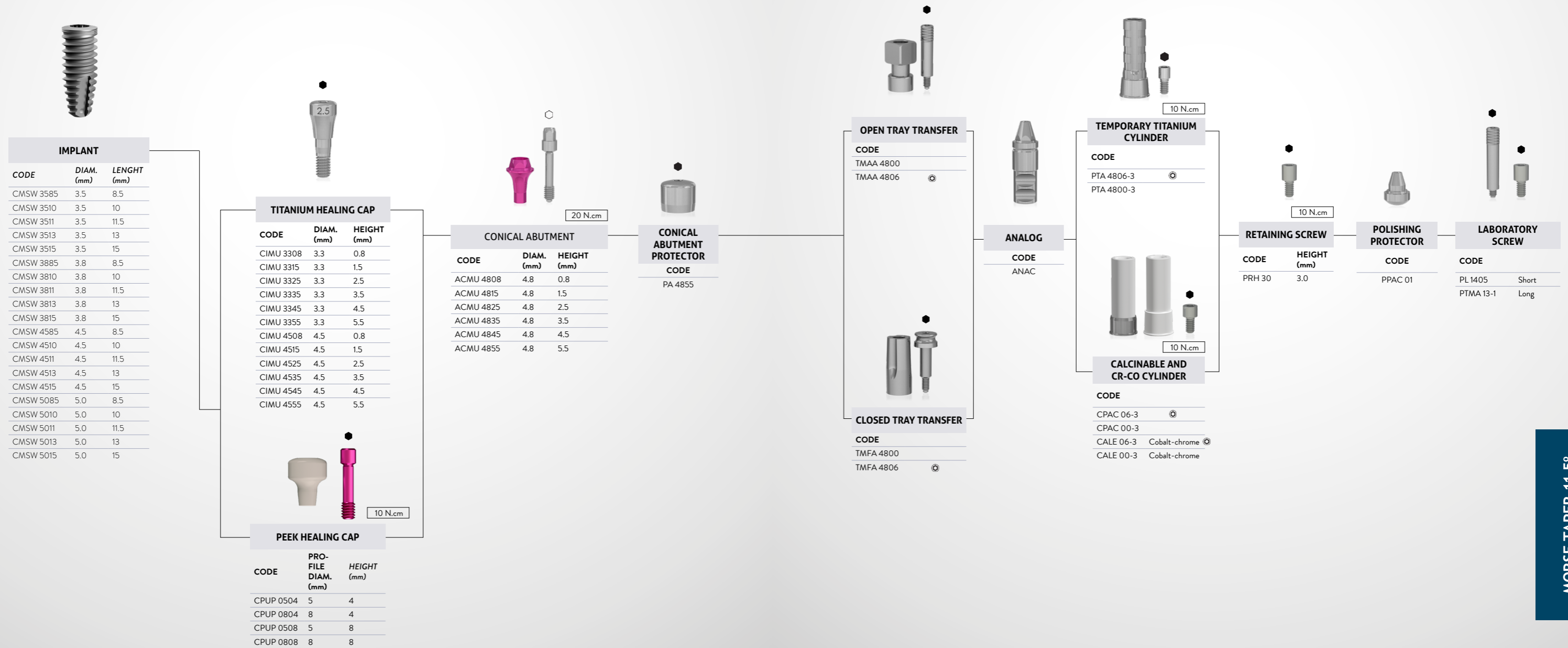

* Check the availability of the products in your region.

- *Hex Screw
- ⊙ *Anti-Rotational Component
- *Squared Screw
- *Abutment Screw
- ⊙ *Rotational Component

11.5° MORSE TAPER PROSTHETIC SEQUENCE

MULTI-UNIT ABUTMENTS

MULTIPLE SCREW RETAINED RESTORATIONS

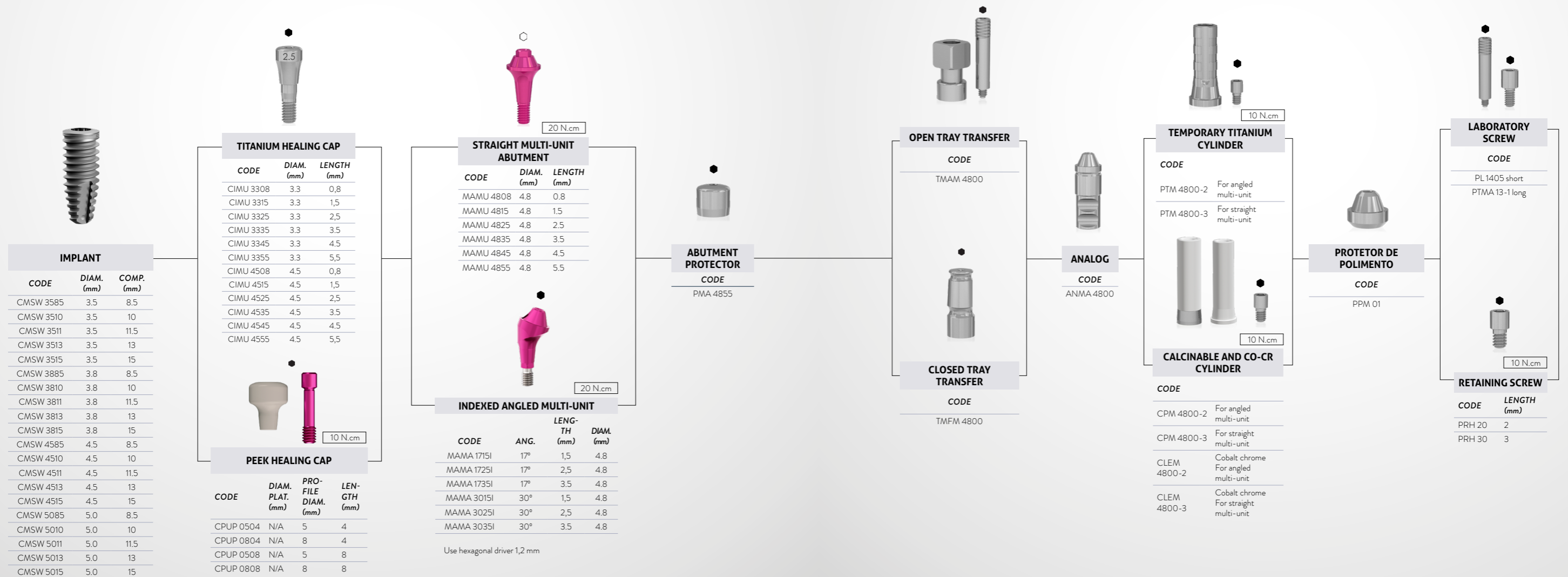

* Check the availability of the products in your region.

- *Hex Screw
- ⊙ *Anti-Rotational Component
- *Square Screw
- ⬡ *Abutment Screw
- ⊙ *Rotational component

11.5° MORSE TAPER PROSTHETIC SEQUENCE

MULTI-UNIT ABUTMENTS

SINGLE/MULTIPLE SCREW RETAINED RESTORATIONS

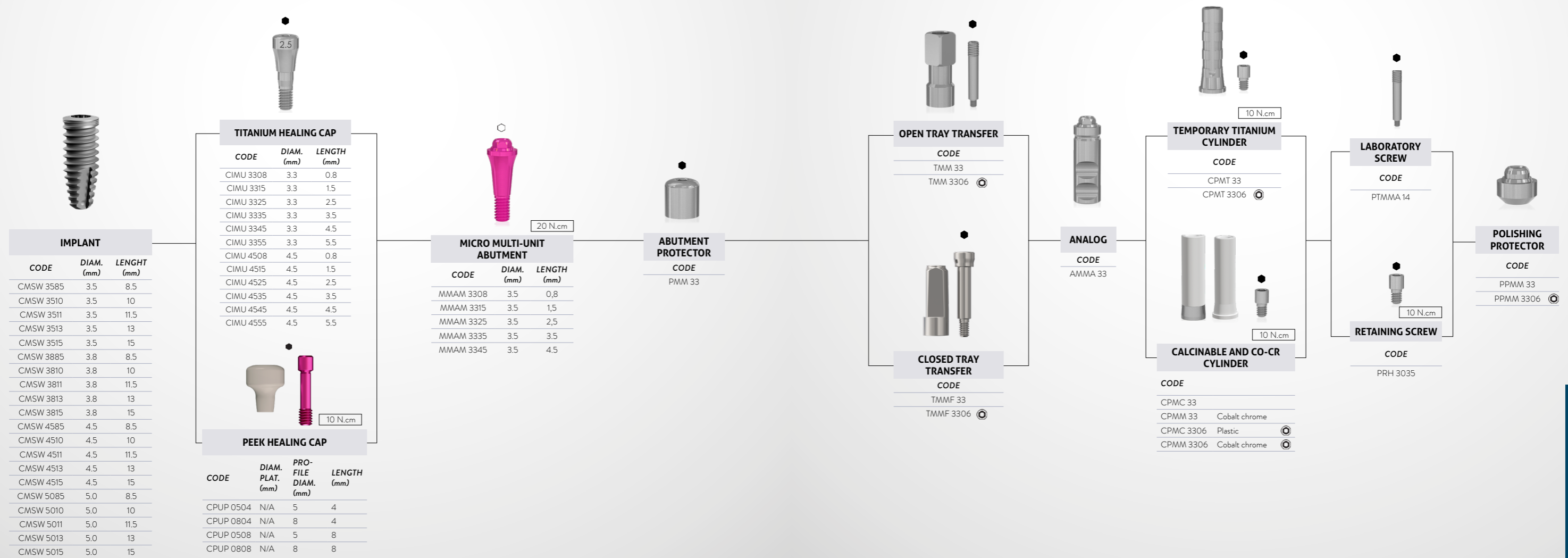

* Check the availability of the products in your region.

- *Hex Screw
- ⊙ *Anti-Rotational Component
- *Square Screw
- ⬡ *Abutment Screw
- ⊙ *Rotational component

11.5° MORSE TAPER PROSTHETIC SEQUENCE

OVERDENTURE SOLUTIONS MULTI-UNIT + BAR-CLIP RESTORATIONS

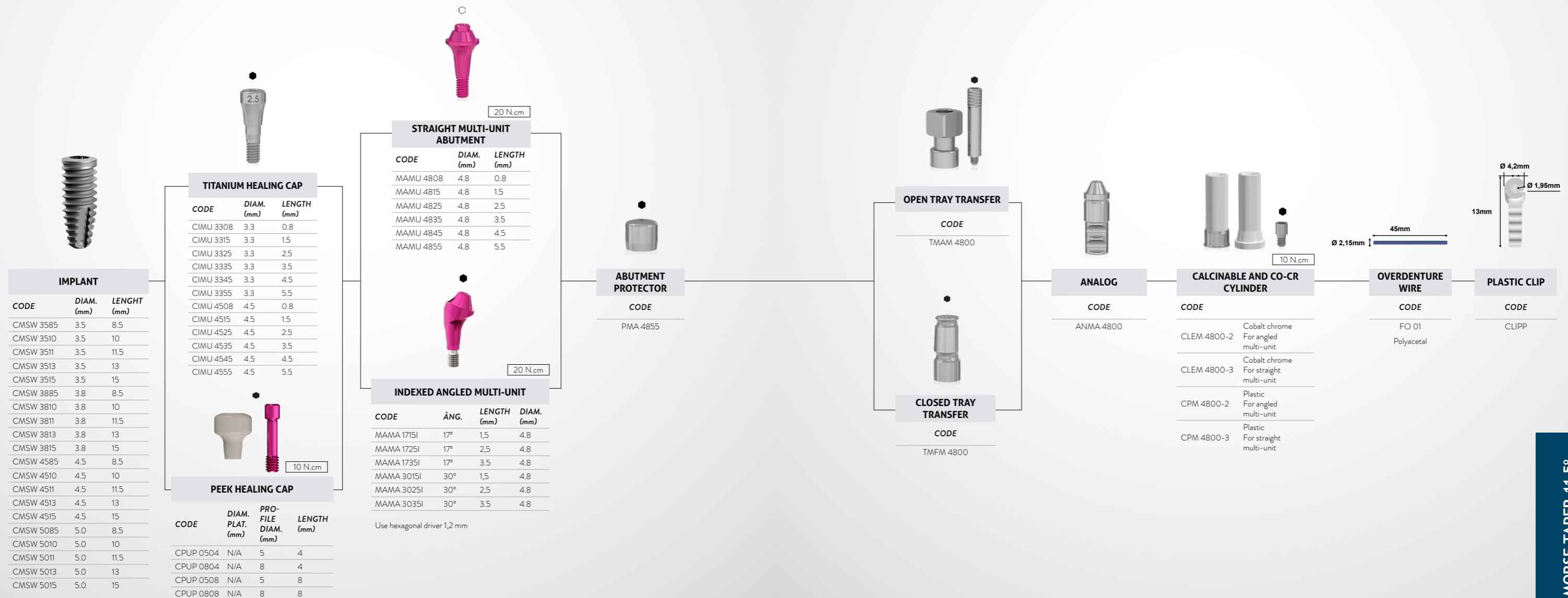

MORSE TAPER 11.5°

* Check the availability of the products in your region.

- *Hex Screw
- ⊙ *Anti-Rotational Component
- *Square Screw
- ⊕ *Abutment Screw
- ⊗ *Rotational component

STRONG SW SURGICAL KIT A SINGLE KIT, SEVERAL POSSIBILITIES

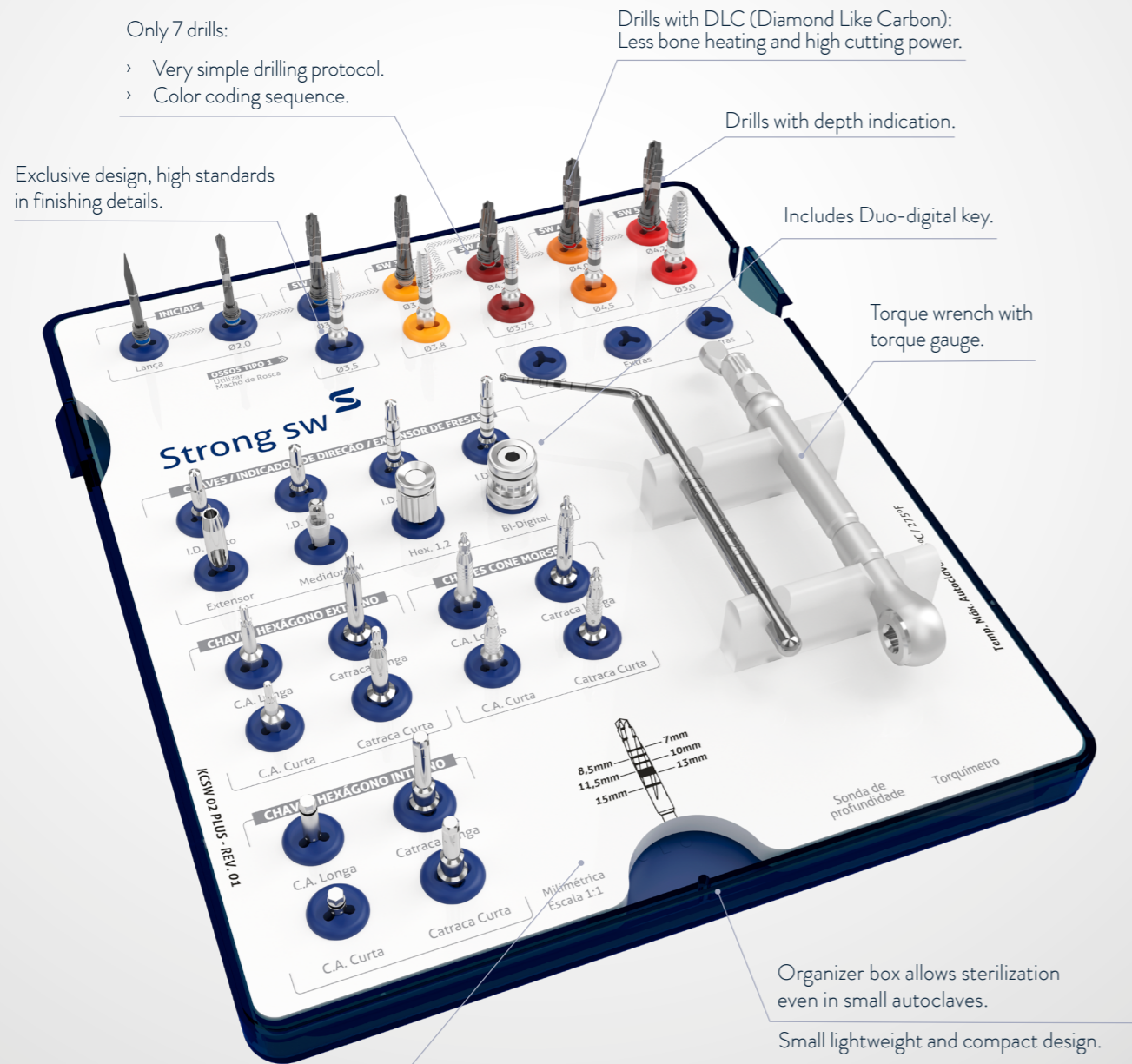

Only 7 drills:

- > Very simple drilling protocol.
- > Color coding sequence.

Drills with DLC (Diamond Like Carbon):
Less bone heating and high cutting power.

Drills with depth indication.

Includes Duo-digital key.

Torque wrench with torque gauge.

Organizer box allows sterilization even in small autoclaves.

Small lightweight and compact design.

A single kit for the entire Strong SW line: possibility of installing Cone Morse, External and Internal Hex implants with the same kit.

CODE: KCSW 02

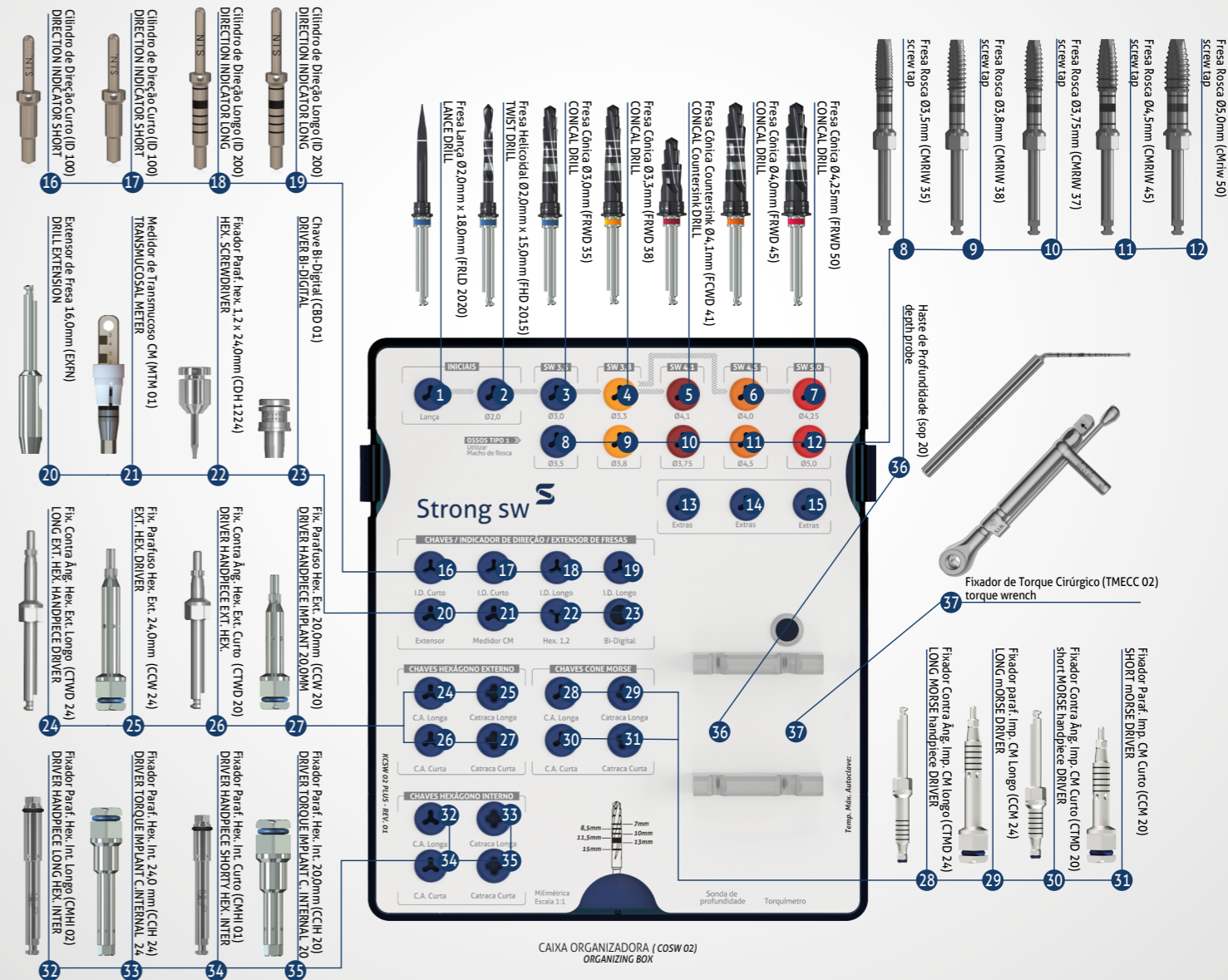

SAFE DRILL KIT

ACCURACY, SAFETY AND LESS SURGERY TIME.

Color-coding system simplifies the clinical use.



The Safe Drill Strong SW Kit is only compatible with the Strong SW Surgical

Performance and efficiency: unique polyacetal limiters with perfect fit and high strength, which ensures greater durability of the kit.

Accuracy and safety: Safe drilling to desired depth, eliminating visual control and osteotomy pauses.

For the cone morse infra-bone installation, it is required to use the ring with 1.5 mm higher than the desired implant height.

CODE: KWS D 02 CODE: COW SD 02

CODE	DESCRIPTION
LSDD 2007	SAFE DRILL STOPPER Ø2.00/Ø2.70X7.0MM
LSDD 2085	SAFE DRILL STOPPER Ø2.00/Ø2.70X8.5MM
LSDD 2010	SAFE DRILL STOPPER Ø2.00/Ø2.70X10.0MM
LSDD 2011	SAFE DRILL STOPPER Ø2.00/Ø2.70X11.5MM
LSDD 2013	SAFE DRILL STOPPER Ø2.00/Ø2.70X13.0MM
LSDD 2015	SAFE DRILL STOPPER Ø2.00/Ø2.70X15.0MM
LSDD 3007	SAFE DRILL STOPPER Ø3.00/Ø3.30X7.0MM
LSDD 3085	SAFE DRILL STOPPER Ø3.00/Ø3.30X8.5MM
LSDD 3010	SAFE DRILL STOPPER Ø3.00/Ø3.30X10.0MM
LSDD 3011	SAFE DRILL STOPPER Ø3.00/Ø3.30X11.5MM

CODE	DESCRIPTION
LSDD 3013	SAFE DRILL STOPPER Ø3.00/Ø3.30X13.0MM
LSDD 3015	SAFE DRILL STOPPER Ø3.00/Ø3.30X15.0MM
LSDD 3807	SAFE DRILL STOPPER Ø3.80/Ø4.25X7.0MM
LSDD 3885	SAFE DRILL STOPPER Ø3.80/Ø4.25X8.5MM
LSDD 3810	SAFE DRILL STOPPER Ø3.80/Ø4.25X10.0MM
LSDD 3811	SAFE DRILL STOPPER Ø3.80/Ø4.25X11.5MM
LSDD 3813	SAFE DRILL STOPPER Ø3.80/Ø4.25X13.0MM
LSDD 3815	SAFE DRILL STOPPER Ø3.80/Ø4.25X15.0MM
COW SD 02	SAFE DRILL ORGANIZING BOX SW

SHORT DRILL KIT

STRONG SW COMPLETE MILLING SYSTEM

Drill length: 27; 28.5 and 29 mm.

Milimetric markings of 7; 8.5 and 10 mm.

Stainless steel and DLC coating (Diamond Like Carbon): increased cutting power, ensuring less bone heating.



CODE: KSDSW

CODE	DESCRIPTION
FRLD 2020C	LANCE DRILL Ø2.0MM SHORT
FHD 2010C	HELICAL DRILL Ø2.0X10MM SHORT
FRWD 35C	CONICAL DRILL Ø3.0MM SHORT
FRWD 38C	CONICAL DRILL Ø3.3MM SHORT
FRWD 45C	CONICAL DRILL Ø4.0MM SHORT
FRWD 50C	CONICAL DRILL Ø4.25MM SHORT
FCWD 41C	COUNTERSINK DRILL Ø4.1MM SHORT

STRONG SW GUIDED SURGERY KIT COMPLETE AND COMPACT KITS

Developed with high-tech innovation and superior industrial quality, **Strong SW Guided Surgery Kit** provides several benefits throughout the dental implant installation procedure.

Now you can offer your patients **a more comfortable surgery, accurate precision, reduced surgical time and better postoperative recovery.**

Discover what is the best in worldwide implantology.

Color coding
Modern and easy to browse through.

Possibility of installation
in different diameters*,
lengths and platforms
line prosthetics.

Integrated Safe Drill system
limiters that allow precise
control of the alveolus depth.

Narrow sleeve system
It **AVOIDS COLLISION BETWEEN
GUIDE SLEEVES** and orientation errors
at short mesio-distal distances.

Flexible sleeve positioning system
> It allows the **PLACEMENT OF THE SURGICAL
GUIDES IN TWO DIFFERENT POSITIONS**
in relation to the bone level.

Long and short drill system
> Greater range of options
according to the clinical case.

Standard drill: 42.5mm
> Millimetric depth markings;
> Safe Drill fitting;
> Recommended for all types of
procedure.

*except 5mm diameter

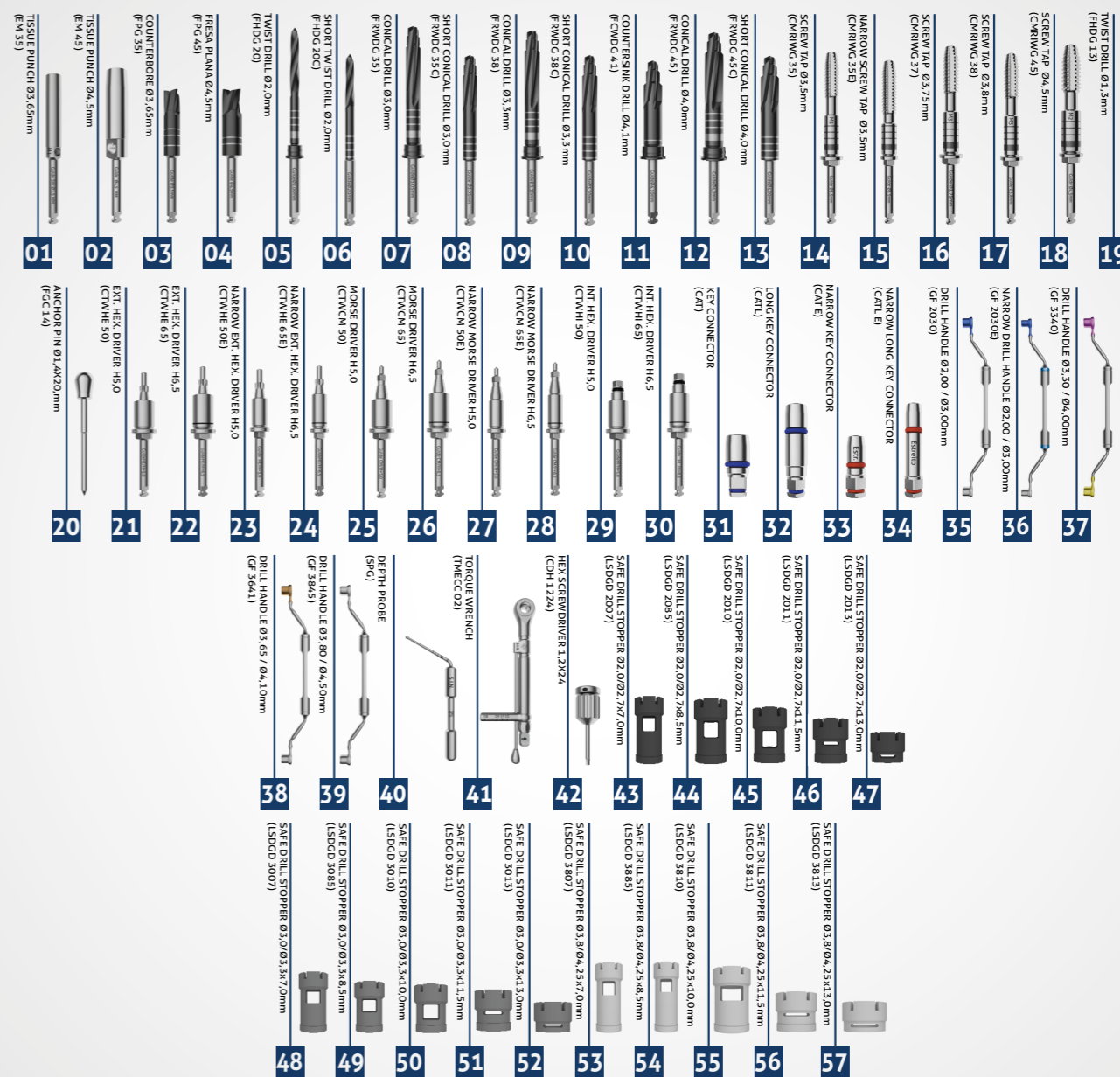

Organizing Box Strong SW Guided Surgery Kit

*Check product availability in your country.

PROSTHETIC KIT

FUNCTIONAL, PRACTICAL AND COMPACT



CODE: KTEC 02

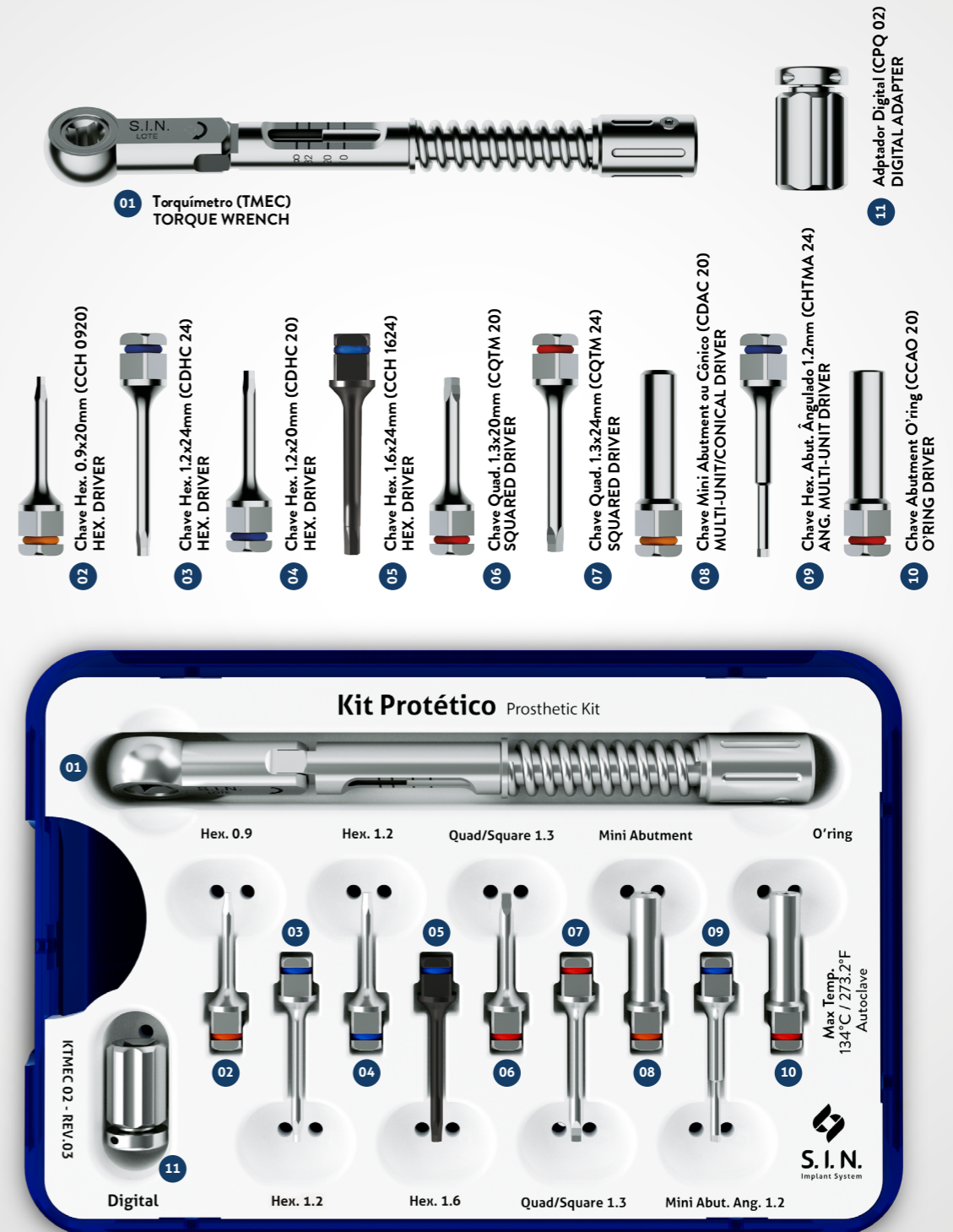

ORGANIZING BOX (COTMEC)

BONE EXPANDER KIT

Ideal for performing lateral bone expansion, the Bone Expander Kit is the essential tool for its clinical ease, in addition to avoiding the need to use bone grafts.



CODE: KEXP
ORGANIZING BOX: COEXP

CODE	DESCRIPTION
SXPS 01	Expansor with stop 1 - ø 1.65 mm Tip
SXPS 02	Expansor with stop 2 - ø 1.90 mm Tip
SXPS 03	Expansor with stop 3 - ø 2.85 mm Tip
SXPS 04	Expansor with stop 4 - ø 2.85 mm Tip
COEXP	Expander Organizing Box

BONE GRAFT SURGICAL KIT

Used for stabilization of bone grafts in block and for guided bone regeneration surgery, the Bone Graft Kit has a key with a cross-fit, in order to give more precision when making use of the screws.

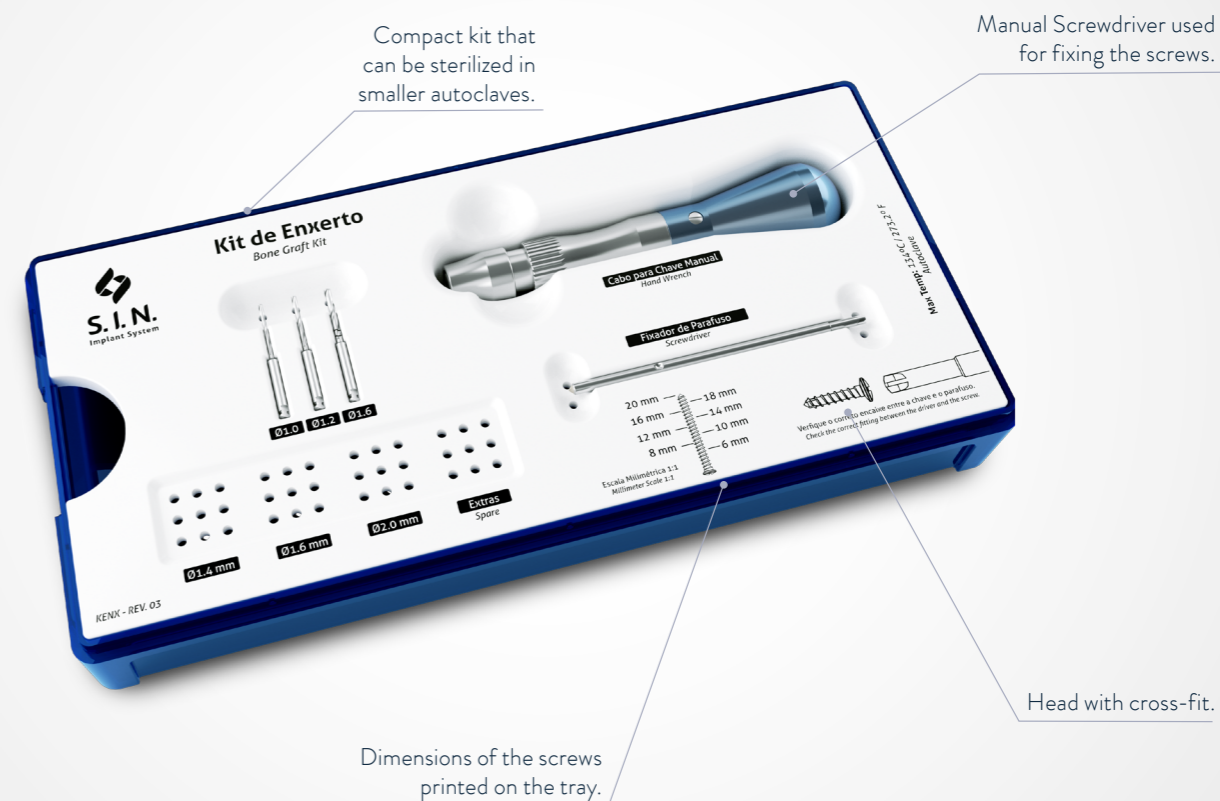

CÓDIGO: KENX
ORGANIZING BOX: COENX

BONE GRAFT SCREWS



CODE	DIAM.	LENGTH
PEX 1408	1.4 mm	8.0 mm
PEX 1410	1.4 mm	10.0 mm
PEX 1412	1.4 mm	12.0 mm
PEX 1608	1.6 mm	8.0 mm
PEX 1610	1.6 mm	10.0 mm
PEX 1612	1.6 mm	12.0 mm

CODE	DESCRIPTION
CDM 02	Hand Wrench
CPEX	Screwdriver
FH 1015	DRILL HELICAL ø 1.0 mm x 15.0 mm
FH 1215	DRILL HELICAL ø 1.2 mm x 15.0mm
FH 1615	DRILL HELICAL ø 1.6 mm x 15.0mm
COENX	BONE GRAFT ORGANIZING BOX

NOTE: Screws are sold separately

SINUS LIFT KIT

Indicated for sinus lift surgery, the Sinus Lift Kit enables the sinus membrane to be displaced, as well as curettage and compaction of the bone graft.

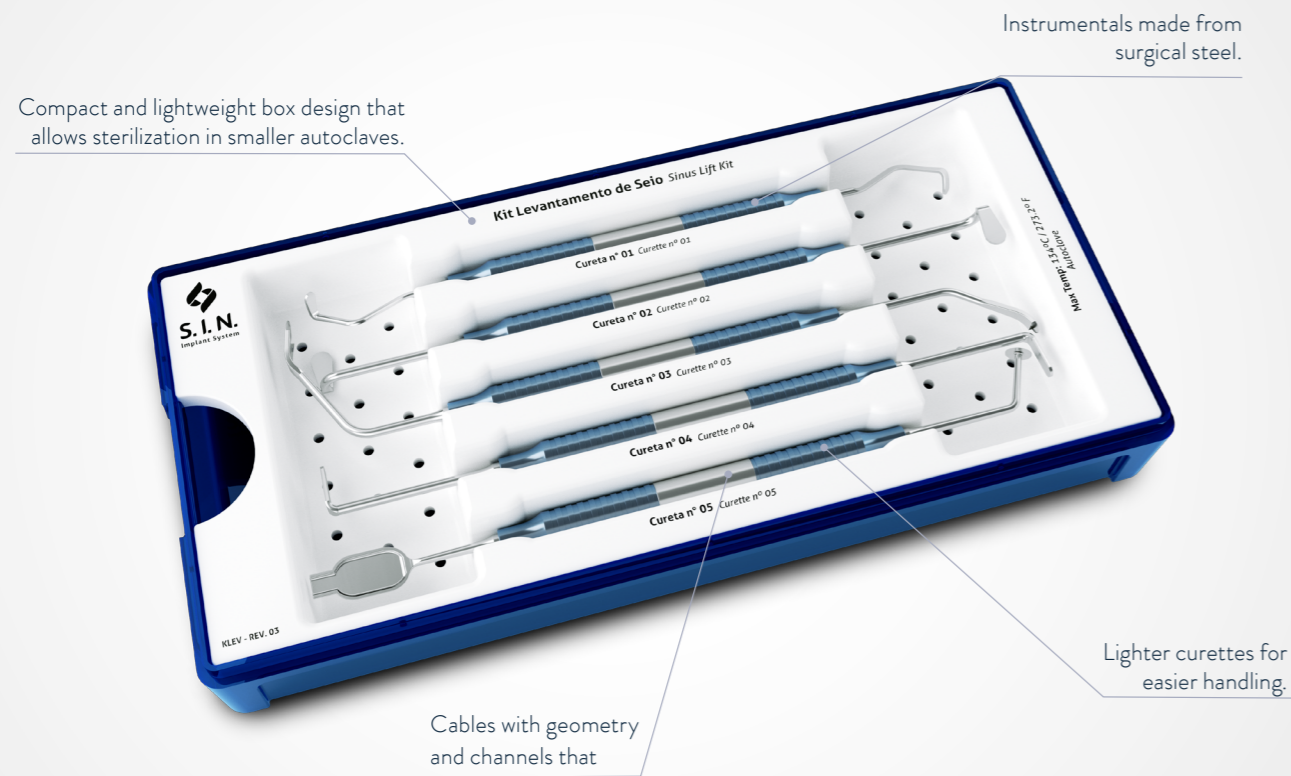

CODE: KLEV 02
ORGANIZING BOX: COLEV

CODE	DESCRIPTION
CRT 01	Curette 01
CRT 02	Curette 02
CRT 03	Curette 03
CRT 04	Curette 04
CRT 05	Curette 05
COLEV	Sinus Lift Organizing Box

OSTEOTOME KIT

It enables the performance of atraumatic maxillary sinus elevation, which results in vertical bone gain, the Osteotome Kit is the ideal tool for its cases and avoids the need for bone grafting.

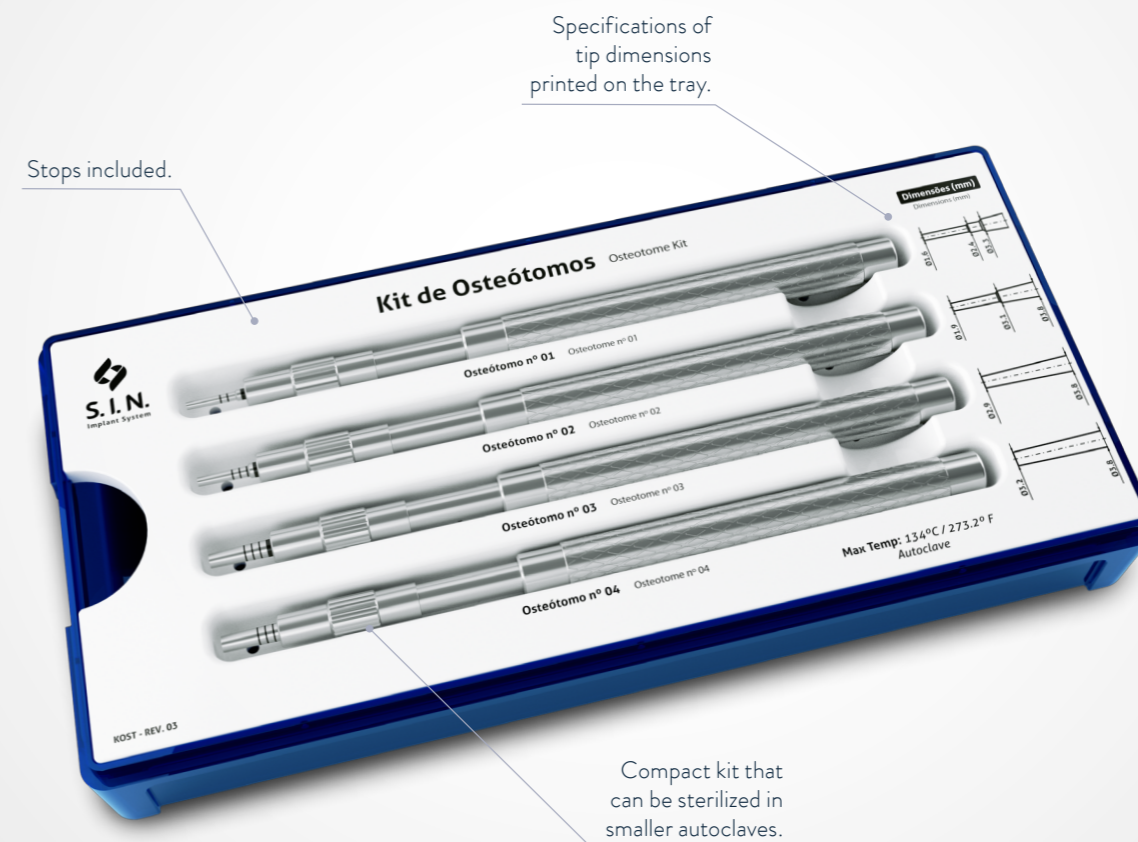

CODE: KOST
ORGANIZING BOX: COOST

CODE	DESCRIPTION
SOST 01	OSTEOTOME SUMMER W/ STOP 1 - ø 1.60 mm Tip
SOST 02	OSTEOTOME SUMMER W/ STOP 2 - ø 1.90 mm Tip
SOST 03	OSTEOTOME SUMMER W/ STOP 3 - ø 2.90 mm Tip
SOST 04	OSTEOTOME SUMMER W/ STOP 4 - ø 3.20 mm Tip
COOST	OSTEOTOME ORGANIZING BOX

ROTARY EXPANDING KIT

Indicated for situations of little bone thickness, besides having 3 options, being ratchet, contra-angle and digital key. Recommended for bone expansion and compaction and avoids the need for bone grafting.



CODE: KER
ORGANIZING BOX: COER

CODE	DESCRIPTION
CPQ 02	Prosthetic Drum
CQCA 27	Contra-angle square drive
COER	Rotary Expanding Box
EXR 01	Rotary Expander 01 - ø 1.4 mm to ø 2.35 mm
EXR 02	Rotary Expander 02 - ø 1.4 mm to ø 3.05 mm
EXR 03	Rotary Expander 03 - ø 2.85 mm to ø 3.85 mm
EXR 04	Rotary Expander 04 - ø 3.15 mm to ø 4.25 mm
FRL2020	Drill Lance ø 2.00 mm x 20.0 mm

ORTHODONTIC KIT

Kit with surgical simplicity for installation and removal of mini screws, aiding in orthodontic treatment.

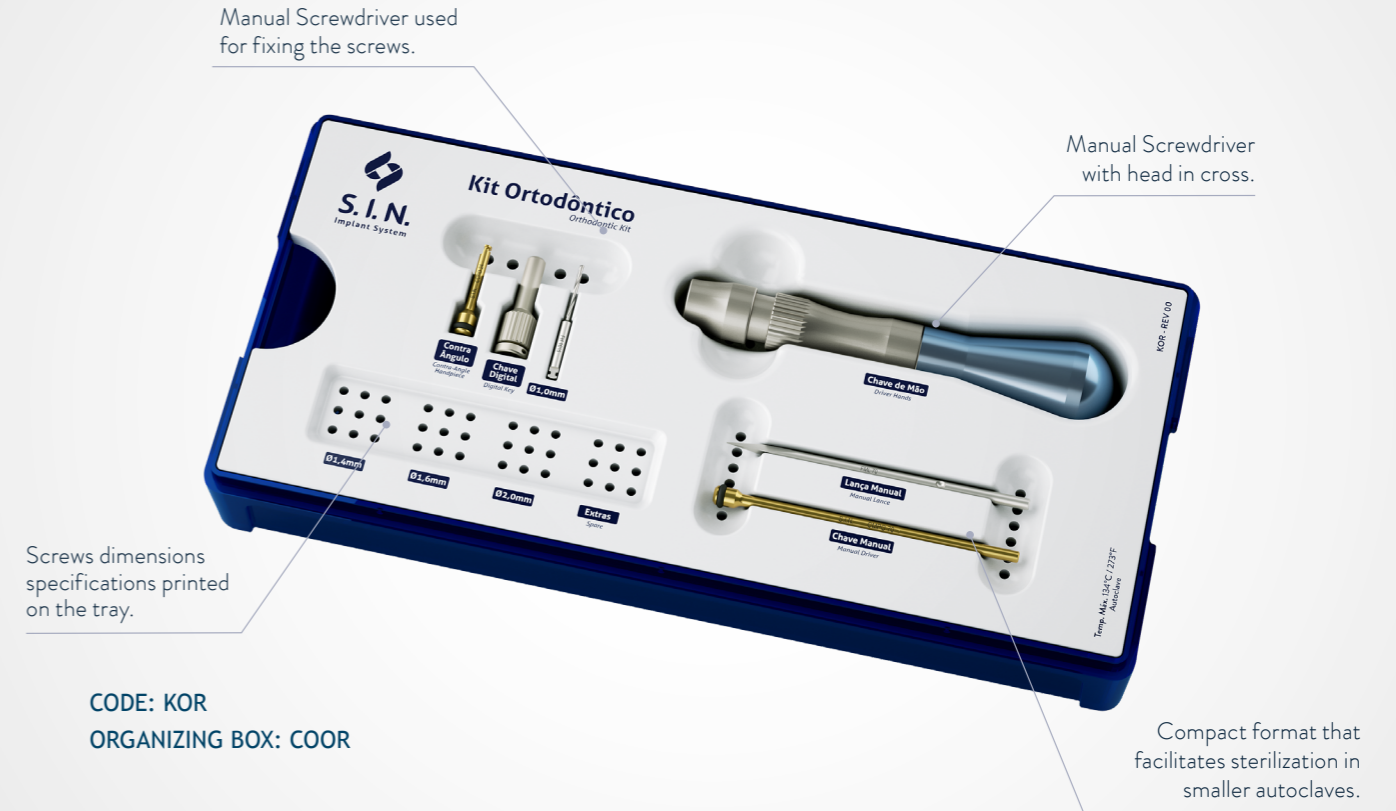

CODE: KOR
ORGANIZING BOX: COOR

CODE	DESCRIPTION
CMPO 70	Hand wrench for micro orthodontic screws - High Utility
CCPO 24	Hand wrench for orthodontic screws - High Utility
FML 70	Manual lance-type drill
FH 1015	Twist Drill 1,0 x 15 mm
CDM 02	Hand wrench
CDPO 24	Digital Key for Orthodontic Screw (for final screw installation only)
COOR	Orthodontic Kit Set

NOTE: Screws are sold separately.

ORTHODONTIC MINI-IMPLANTS

- > Easy Installation and Removal.
- > Immediate loading can be done after surgical application.
- > Easy connection with orthodontic accessories.
- > Hole diameter : 0.6 mm.

AUTO DRILLING APEX:

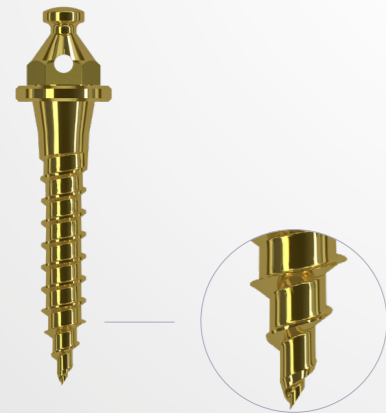

INSTALLATION TECHNICAL INFORMATION

- › **Lengths:**
Gingival depth = 0, 1, 2 and 3 mm.
Length = 6, 8 and 10 mm.
- › **Diameter:**
1.4 mm
1.6 mm
1.8 mm

SELF-DRILLING WITHOUT TRANSMUCOSAL PROFILE



CODE	DIAM.	LENGTH.
POT 1406	1,4 mm	6,0 mm
POT 1408	1,4 mm	8,0 mm
POT 1400	1,4 mm	10,0 mm
POT 1606	1,6 mm	6,0 mm
POT 1608	1,6 mm	8,0 mm
POT 1600	1,6 mm	10,0 mm
POT 1806	1,8 mm	6,0 mm
POT 1808	1,8 mm	8,0 mm
POT 1800	1,8 mm	10,0 mm

SELF-DRILLING WITHOUT TRANSMUCOSAL PROFILE (2MM)



CODE	DIAM.	LENGTH
POT 1420	1,4 mm	10,0 mm
POT 1428	1,4 mm	8,0 mm
POT 1620	1,6 mm	10,0 mm
POT 1628	1,6 mm	8,0 mm
POT 1820	1,8 mm	10,0 mm
POT 1828	1,8 mm	8,0 mm

SELF-DRILLING WITHOUT TRANSMUCOSAL PROFILE (1MM)



CDE	DIAM.	COMP.
POT 1416	1,4 mm	6,0 mm
POT 1418	1,4 mm	8,0 mm
POT 1410	1,4 mm	10,0 mm
POT 1616	1,6 mm	6,0 mm
POT 1618	1,6 mm	8,0 mm
POT 1610	1,6 mm	10,0 mm
POT 1816	1,8 mm	6,0 mm
POT 1818	1,8 mm	8,0 mm
POT 1810	1,8 mm	10,0 mm





SELF-DRILLING WITHOUT TRANSMUCOSAL PROFILE (3MM)

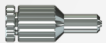

CODE	DIAM.	LENGTH
POT 1438	1,4 mm	8,0 mm
POT 1430	1,4 mm	10,0 mm
POT 1638	1,6 mm	8,0 mm
POT 1630	1,6 mm	10,0 mm
POT 1838	1,8 mm	8,0 mm
POT 1830	1,8 mm	10,0 mm

INSTRUMENTAL OF COMPLEMENTARY KITS

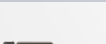
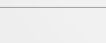
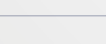
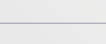
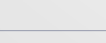

DIGITAL DRIVERS

ITEM	CODE	DESCRIPTION	LENGTH	INDICATION
	CDA 20	ABUTMENT SCREWDRIVER 20,0MM	SHORT	Used to set the mini-abutment and conical abutment screw
	CDA 24	ABUTMENT SCREWDRIVER 24,0MM	LONG	Used to set the mini-abutment and conical abutment screw
	CDH 0920	HEXAGONAL DIGITAL SCREWDRIVER 20,0MM	SHORT	Used for installation of Externa Hex. Tryon implant cover, two-pieces straight universal abut and angled universal abut
	CDH 0924	HEXAGONAL DIGITAL SCREWDRIVER 24,0MM	LONG	Used for installation of Externa Hex. Tryon implant cover, two-pieces straight universal abut and angled universal abut
	CDH 1220	HEXAGONAL DIGITAL SCREWDRIVER 20,0MM	SHORT	Used to set the mounting piece, healing, transfer, retaining screw (PTL 16, PT 2006, PT 2008, PRH 20 and PRH 30) and lab screws. 1.2mm hexagonal tip
	CDH 1224	HEXAGONAL DIGITAL SCREWDRIVER 24,0MM	LONG	Used to set the mounting piece, healing, transfer, retaining screw (PTL 16, PT 2006, PT 2008, PRH 20 and PRH 30) and lab screws. 1.2mm hexagonal tip
	CDHA 1220	HEX. DIGITAL SCREWDRIVER 20.0MM ANG. MINI-ABUTMENT	SHORT	Used to set the angular mini-abutment screw 1.2mm hexagonal tip (except for the Unitite angular mini-abutment).
	CDHA 1224	HEX. DIGITAL SCREWDRIVER 24.0MM ANG. MINI-ABUTMENT	LONG	Used to set the angular mini-abutment screw 1.2mm hexagonal tip (except for the Unitite angular mini-abutment).
	CDHA 1237	HEX. DIGITAL SCREWDRIVER 37.0MM ANG. MINI-ABUTMENT	EXTRA LONG	Used to set the angular mini-abutment screw 1.2mm hexagonal tip (except for the Unitite angular mini-abutment).
	CDQ 1220	SQUARE DIGITAL SCREWDRIVER 20.0MM	SHORT	Used to set the square-fit retaining screws (PTQ 2008, PTQH 18 and PTQ 2006). 1.3mm tip



SURGICAL HAMMER

ITEM	CODE	DESCRIPTION
	MART1	<ul style="list-style-type: none"> > Surgical-grade stainless steel used with Osteotome and Expander kits. > Contact end made of synthetic material that provides improved sensitivity, less impact and reduced trauma during use

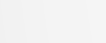
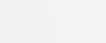
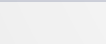
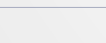
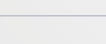
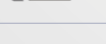
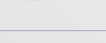

DIGITAL DRIVERS

ITEM	CODE	DESCRIPTION	LENGTH	INDICATION
	CDQ 1224	SQUARE DIGITAL SCREWDRIVER 24,0MM	LONG	Used to set the square-fit locking screws (PTQ 2008, PTQH 18 and PTQ 2006). 1.3mm tip
	CDQ 1237	SQUARE DIGITAL SCREWDRIVER 37.0MM	EXTRA LONG	Used to set the square-fit locking screws (PTQ 2008, PTQH 18 and PTQ 2006). 1.3mm tip
	CLH 1277	HEX. SCREWDRIVER 77,0MM	EXTRA LONG	Lab screwdriver. Used to set retaining screws (PTL 16, PT 2006, PT 2008, PRH 20 and PRH 30) and lab screws. 1.2mm hexagonal tip
	CLQ 1277	HEX. SCREWDRIVER 77,0MM	EXTRA LONG	Lab screwdriver. Used to set the square-fit retaining screws (PTQ 2008, PTQH 18 and PTQ 2006). 1.3mm tip
	CRC 16	PROVISIONAL CYLINDER REMOVAL SCREWDRIVER	SHORT	Used to remove 1.6mm Cone Morse Strong SW provisional cylinder
	CRC 18	PROVISIONAL CYLINDER REMOVAL SCREWDRIVER	SHORT	Used to remove the 1.8 mm Cone Morse Strong SW provisional cylinder
	CDH 1620	HEX DIGITAL DRIVER 1.6MM	SHORT	Used to set Multifunctional Abutment. 1.6mm Hex lid
	CDH 1624	HEX DIGITAL DRIVER 1.6MM	MEDIUM	Used to set Multifunctional Abutment. 1.6mm Hex lid
	CCH 1620	RATCHET HEX DRIVER 1.6MM	SHORT	Used to set and torque of the Multifunction Abutment. 1.6mm Hex lid
	CCH 1624	RATCHET HEX DRIVER 1.6MM	MEDIUM	Used to set and torque of the Multifunction Abutment. 1.6mm Hex lid



BONE PROFILING MILLING CUTTERS

ITEM	CODE	DESCRIPTION	INDICATION
	PO 4150	Platform 4.1 mm – External Hex.	Opens bone profile to 5.0 mm
	PO 5055	Platform 5.0 mm – External Hex.	Opens bone profile to 5.5 mm

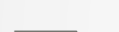
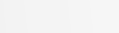
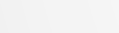
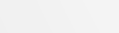
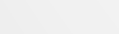
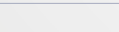
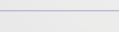
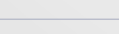
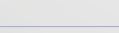
COUNTER-ANGLE SCREWDRIVER

ITEM	CODE	DESCRIPTION	LENGTH	INDICATION
	CTA 1224	ABUTMENT TORQUE SCREWDRIVER 24,0MM	LONG	Used to set the mini-abutment and conical abutment screw
	CTH 0924	COUNTER-ANGLE HEXAGONAL TORQUE SCREWDRIVER 24,0MM	LONG	Used for installation of Externa Hex. Tryon implant cover, two-pieces straight universal abut and angled universal abut.
	CTH 1220	COUNTER-ANGLE HEXAGONAL TORQUE SCREWDRIVER 20,0MM	SHORT	Used to set the mounting piece, healing, transfer, retaining screws (PTL 16, PT 2006, PT 2008, PRH 20 and PRH 30) and lab screws. 1.2mm hexagonal tip
	CTH 1224	COUNTER-ANGLE HEXAGONAL TORQUE SCREWDRIVER 24,0MM	LONG	Used to set the mounting piece, healing, transfer, retaining screws (PTL 16, PT 2006, PT 2008, PRH 20 and PRH 30) and lab screws. 1.2mm hexagonal tip
	CTH 1230	COUNTER-ANGLE HEXAGONAL TORQUE SCREWDRIVER 30,0MM	EXTRA LONG	Used to set the mounting piece, healing, transfer, retaining screws (PTL 16, PT 2006, PT 2008, PRH 20 and PRH 30) and lab screws. 1.2mm hexagonal tip
	CTHA 1220	ANGULAR MINI-ABUTMENT COUNTER-ANGLE HEXAGONAL TORQUE SCREWDRIVER 20,0MM	SHORT	Used to set the angular mini-abutment screw 1.2mm hexagonal tip (except for the Unitite angular mini-abutment).
	CTHA 1224	ANGULAR MINI-ABUTMENT COUNTER-ANGLE HEXAGONAL TORQUE SCREWDRIVER 24,0MM	LONG	Used to set the angular mini-abutment screw 1.2mm hexagonal tip (except for the Unitite angular mini-abutment).
	CTQ 20	SQUARE TORQUE SCREWDRIVER 20,0MM	SHORT	Used counter-angle to set square-fit retaining screws (PTQ 2008, PTQH 18 and PTQ 2006). 1.3mm tip
	CTQ 24	SQUARE TORQUE SCREWDRIVER 24,0MM	LONG	Used counter-angle to set square-fit retaining screws (PTQ 2008, PTQH 18 and PTQ 2006). 1.3mm tip
	CTQ 30	SQUARE TORQUE SCREWDRIVER 30,0MM	EXTRA LONG	Used counter-angle to set square-fit retaining screws (PTQ 2008, PTQH 18 and PTQ 2006). 1.3mm tip
	CTH 1620	COUNTER-ANGLE HEX DRIVER 1.6MM	SHORT	Multifunctional Abutment.
	CTH 1624	COUNTER-ANGLE HEX DRIVER 1.6MM	MEDIUM	Multifunctional Abutment.

HELICAL MILLING CUTTERS

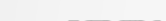
ITEM	CODE	MEASUREMENTS	DESCRIPTION
	FH 2010	ø 2.0x 10,0 mm	
	FH2020	ø 2.0x 18,0 mm	> Surgical-grade stainless steel > Thermal treatment
	FH3010	ø 3.0x 10,0 mm	> Laser markings > Used as a sequence to make the alveolus
	FH3020	ø 3.0x 18,0 mm	

TREPHINE MILLING

ITEM	CODE	MEASUREMENTS	DESCRIPTION
	FTR 02	ø 2.0 mm	
	FTR04	ø 4,2 mm	> Surgical-grade stainless steel > Thermal treatment
	FTR 05	ø 5,1 mm	> Laser markings > May be used to remove implants, remove bone, and bone biopsy
	FTR 06	ø 6,1 mm	> Measures refer to the inner diameter of the part
	FTR 08	ø 8,0 mm	

MORE EASY AND SAFETY FOR YOUR CLINICAL PROCEDURES

S.I.N. packaging are practical, maintaining the products in their integrity, facilitating the handling and the identification.

- › **01** The package is easy to open and handle even with gloves on.

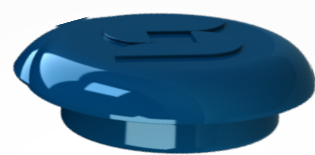

- › **02** Transparency of package for optimal visibility of the implant.



- › **03** Separate compartments in same package for implant and cover.

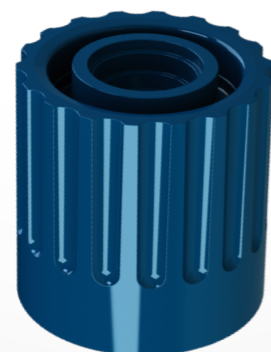

- › **04** Snap-on top opening system ensures sterilization of the implant.

- › **05** With a proper connector, capture the implant with the counter angle key and move it until it reaches the perfect fit.



- › **06** The only implant system that offers the cover screw in the same packaging. To capture it, remove the cover screw of the tube with in the 1.2 mm hexagonal digital key.



The implant should not be captured with the ratchet

SUPERIOR QUALITY AND TECHNOLOGY

WE WARRANT, BECAUSE WE ARE PROUD OF OUR PRODUCTS.

S.I.N.'s main priority is assuring the quality and safety to our clients. Offering the best for implants, components, surgical kits and tooling is the base of all our action.

INSPECTION IN A 100% OF THE BATCHES MANUFACTURED.

The quality control is made in all S.I.N. products, to assure the success in the surgeries of all our clients, to meet the best quality standards, as well as to add value to all the ones who chose to give a smile back to people.



IMPLANTS WITH WARRANTY FOR LIFE*



5 YEARS OF WARRANTY PROSTHESIS COMPONENTS*



*SCAN THE LATERAL QR CODE TO ACCESS S.I.N WARRANTY TERMS OR ACCESS THE LINK [HTTPS://GOO.GL/DIHPFN](https://goo.gl/dihpfn)



TORQUE WRENCH – CLEANING PROCEDURES

The ratchet must be disassembled and cleaned immediately after every use.

For proper cleaning, disassemble multi-piece instruments into their single parts.

No tools are necessary for this process.

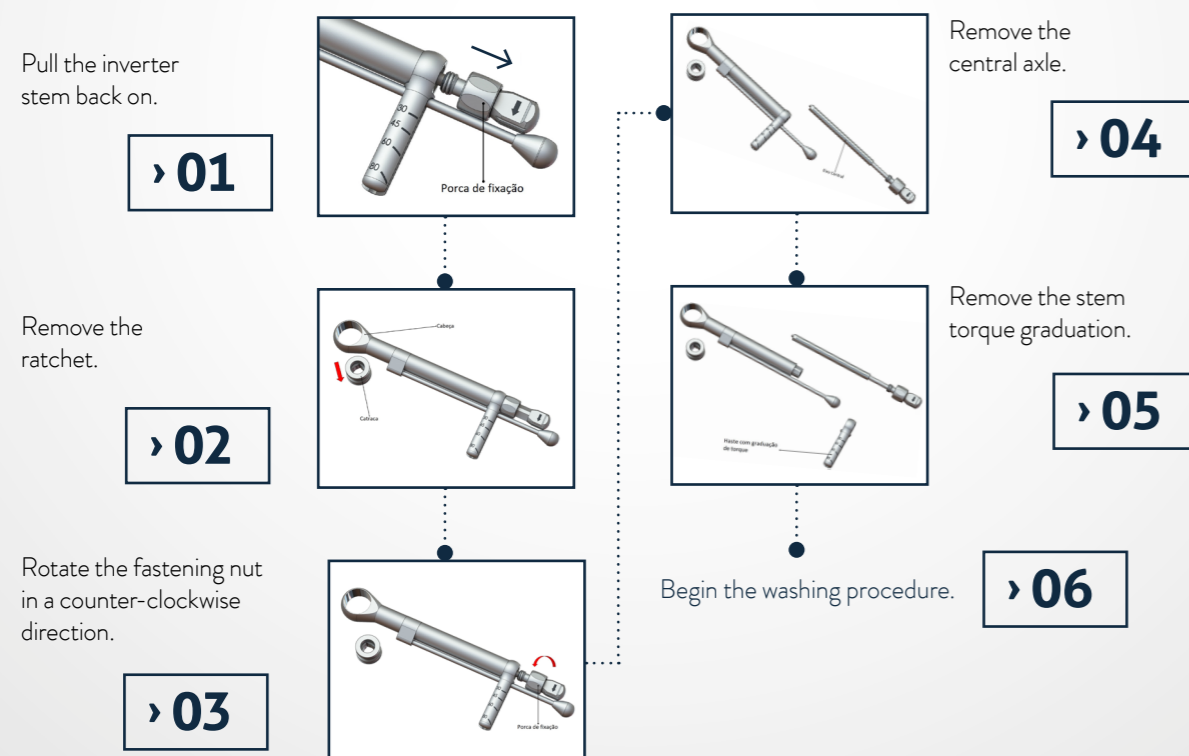

GENERAL INSTRUCTIONS

Special care and clarification on surgical instruments.



CLEANING KIT CASE

- Remove manually all surgical instruments from the kit. Remove the kit box parts (lid, tray and bottom).
- Prepare the enzymatic detergent according to the manufacturer's instructions.
- Immerse the trays in the prepared detergent solution and keep in contact for at least 5 minutes. Then, using soft bristle brush, scrub the parts to remove organic matter from the products.
- Remove the trays from detergent solution and rinse with tap water for 1 minute. Repeat the rinse for two more times, a total of three rinses of 1 minute each.
- Visually inspect each part for cleaning process residue or organic waste from product use.
- If residue is detected in the product, repeat the cleaning process until the residue is completely removed.
- Dry with a soft, clean and dry cloth or disposable paper.



INSTRUMENTS CLEANING

- Disassemble the product (if applicable). For torque wrench, disassemble it completely, remove all internal organic matter using tap water and go to the next step only after performing such procedures.
- Prepare the enzymatic detergent according to the manufacturer's instructions.
- Immerse all product parts into the prepared detergent solution and keep in contact for at least 5 minutes, then using a soft bristle brush, scrub the parts to remove organic matter from the products.
- Remove the parts from the detergent solution and rinse under tap water for 1 minute, repeat the rinse for two more times, a total of three rinses of 1 minute each.
- Visually inspect each part for cleaning process residue or organic waste from product use.
- If residue is detected in the product, repeat the cleaning process until the residue is completely removed.
- Dry with a soft, clean, dry cloth or disposable paper.
- Proceed to the sterilization process.



STERILIZATION

Product provided non-sterile. It must be sterilized in autoclave before use.

- The product must be enclosed in a steam sterilizable wrap.
- Steam sterilize in cycles to 121°C at 1 ATM pressure for 30 minutes or to 134°C at 2 ATM pressure for 20 minutes. Drying time 30 minutes.
- Always accommodate the product in autoclave over a plane surface and away of device walls.
- Never stack objects or other products.

CLEANING RECOMMENDATIONS

- Use the proper PPEs (gloves, masks, goggles, caps, etc.).
- Start the cleaning immediately after the surgical use.
- Never let the instruments dry with organic residues after surgical use.
- Never let the instruments dry naturally after cleaning.
- Never use saline solutions, especially sodium hypochlorite, disinfectants, hydrogen peroxide or alcohol for cleaning or rinsing the surgical instruments and trays of the Kits.
- Never use steel wool or sponges and abrasive products, so that the instruments are not damaged.
- Do not stack instruments in lots to avoid deformation of smaller and delicate parts

STERILIZATION RECOMMENDATIONS

- Sterilize the products in the same day or one day earlier the procedure.
- The chemical sterilization is not recommended once some products may cause damages to the product.
- Do not use temperature higher than 60°C to drying process.
- Do not use dry heat stoves for sterilization of the prosthetic components from S.I.N. - Implant System.

SCIENTIFIC PUBLICATIONS

- › BÁEZ-ROSALES A, et al. Carga inmediata con rehabilitación definitiva en maxilar inferior: reportede caso. Rev Clin Periodoncia Implantol Rehabil Oral. 2015
- › CABRAL L, GUEDES C. Comparative Analysis of 4 Impression Techniques for Implants. Implant Dentistry 2007; 16(2): 187-194
- › CALASANS-MAIA JA, NETO AS, BATISTA MMD, ALVES ATNN, GRANJEIRO JM, CALASANS-MAIA MD. Management of ankylosed young permanent incisors after trauma and prior to implant rehabilitation. Oral Surgery 2013
- › COELHO PG, MARIN C, GRANATO R, BONFANTE EA, LIMA CP, OLIVEIRA S, EHRENFEST DMD, SUZUKI M. Alveolar Buccal Bone Maintenance After Immediate Implantation with a Surgical Flap Approach: A Study in Dogs. The International Journal of Periodontics & Restorative Dentistry 2011; 31: e80–e86
- › DIAS ECLCM, BISOGNIN EDC, HARARI ND, MACHADO SJ, DA SILVA CP, SOARES GDA, VIDIGAL GM. Evaluation of Implant-Abutment Microgap and Bacterial Leakage in Five External-Hex Implant Systems: An In Vitro Study. The International Journal of Oral & Maxillofacial Implants 2012; 27(2): 346-351
- › DUARTE ARC, NETO JPS, SOUZA JCM, BONACHELA WC. Detorque Evaluation of Dental Abutment Screws after Immersion in a Fluoridated Artificial Saliva Solution. Journal of Prosthodontics 2013; 22: 275–281
- › FILHO LCM, CIRANO FR, HAYASHI F, FENG HS, CONTE A, DIB LL, CASATI MZ. Assessment of the Correlation Between Insertion Torque and Resonance Frequency Analysis of Implants Placed in Bone Tissue of Different Densities. Journal of Oral Implantology 2014; 40(3): 259-262
- › FREITAS-JÚNIOR AC, et al. Biomechanical evaluation of internal and external hexagon platform switched implant-abutment connections: An in vitro laboratory and three-dimensional finite element analysis. Dent Mater 2012
- › LORENZONI FC, COELHO PG, BONFANTE G, CARVALHO RM, SILVA NRFA, SUZUKI M, SILVA TL, BONFANTE EA. Sealing Capability and SEM Observation of the Implant-Abutment Interface. International Journal of Dentistry 2011; Article ID 864183
- › MARTINS LMM, BONFANTE EA, ZAVANELLI RA, FREITAS JR AC, SILVA NRFA, MAROTTA L, COELHO PG. Fatigue Reliability of 3 Single-Unit Implant-Abutment Designs. Implant Dentistry 2012; 21(1) 67-71
- › PESSOA RS, BEZERRA FJB, SOUSA RM, SLOTEN JV, CASATI MZ, JAECQUES SVN. Biomechanical Evaluation of Platform Switching: Different Mismatch Sizes, Connection Types, and Implant Protocols. J Periodontol 2014; 85(9)
- › PESSOA RS, COELHO PG, MURARU L, MARCANTONIO Jr E, VAZ LG, SLOTEN JV, JAECQUES, SVN. Influence of Implant Design on the Biomechanical Environment of Immediately Placed Implants: Computed Tomography-Based Nonlinear Three-Dimensional Finite Element Analysis. The International Journal of Oral & Maxillofacial Implants 2011; 26(6): 1279-1287
- › PRATI AJ, CASATI MZ, RIBEIRO FV, CIRANO FR, PASTORE GP, PIMENTEL SP, CASARIN RCV. Release of Bone Markers in Immediately Loaded and Nonloaded Dental Implants: A Randomized Clinical. J Dent Res 2013; 92: 161S
- › RAMOS MB, PEGORATO LF, TAKAMORI E, COELHO PG, SILVA TL, BONFANTE EA. Evaluation of UCLA Implant-Abutment Sealing. The International Journal of Oral & Maxillofacial Implants 2014; 29(1): 113-120
- › ROSA MB, ALBREKTSSON T, FRANCISCHONE CE, SCHWARTZ FILHO HO, WENNEBERG A. Micrometric Characterization of the Implant Surfaces from the Five Largest Companies in Brazil, the Second Largest Worldwide Implant Market. The International Journal of Oral & Maxillofacial Implants 2013; 28(3): 358-365
- › SALGADO AC, MACHADO AN, CARVALHO W, BARBOZA EP, GOUVÊA CVD. Guidelines for Positioning External Hexagon Implants in Screw-Retained Multiple Prosthesis Using Rotational Abutment-Type Components. Implant Dentistry. The International Journal of Oral & Maxillofacial Implants 2014; 23(5): 602-606
- › VALVERDE GB, JIMBO R, TEIXEIRA HS, BONFANTE EA, JANAL MN, COELHO PG. Evaluation of surface roughness as a function of multiple blasting processing variables. Clin. Oral Impl. Res. 2011, 1–5.
- › ZANARDI PR, COSTA B, STEGUN RC, SESMA N, MORI M, LAGANÁ DC. Connecting Accuracy of Interchanged Prosthetic Abutments to Different Dental Implants Using Scanning Electron Microscopy. Braz Dent J 2012; 23(5): 502-507

WHERE WE ARE

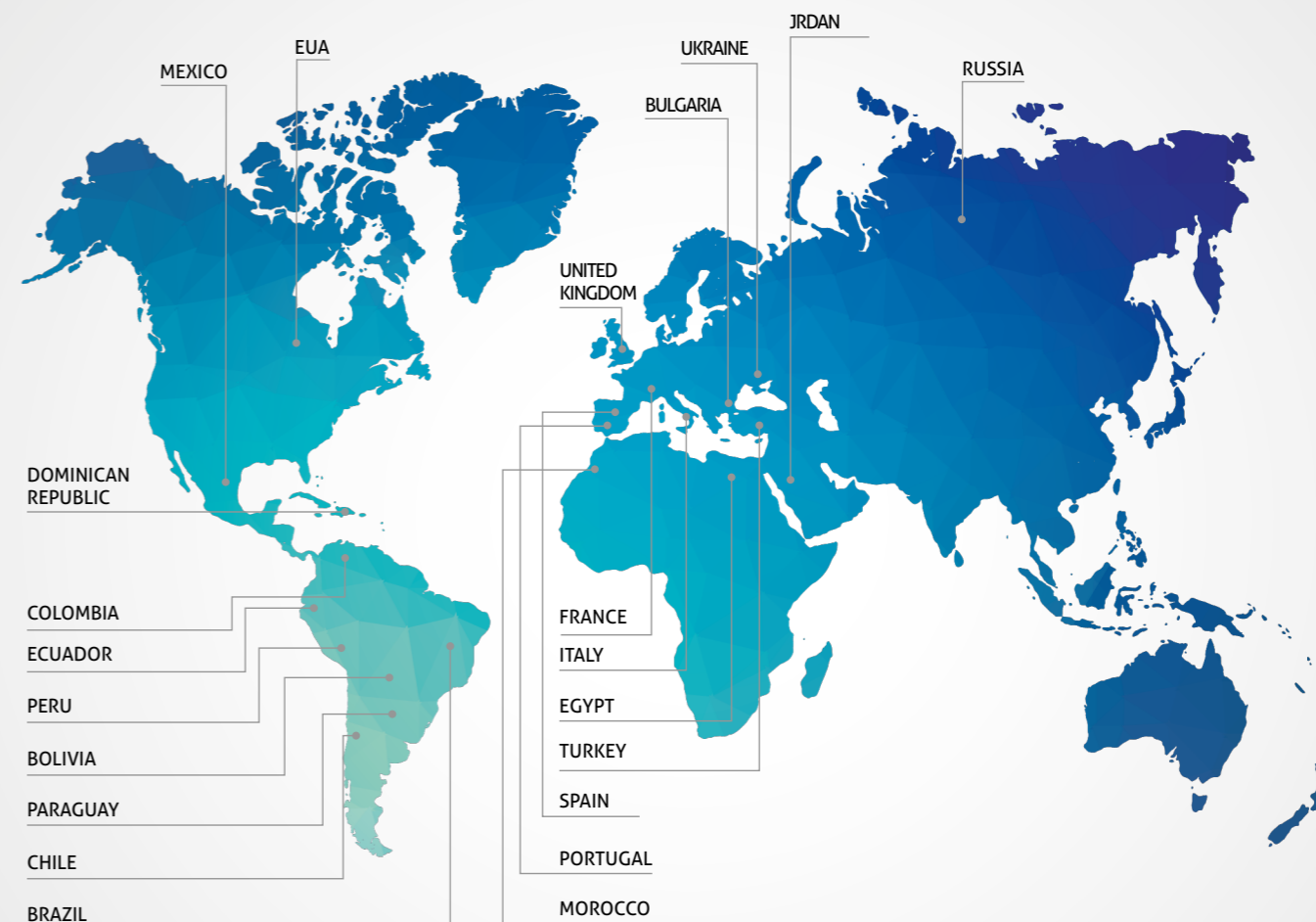

1-866-507-9315

SINdentalusa.com

www.sinimplantsystem.com.br



Discover Implantat, the educational habitat of S.I.N. Implant System.

 [implantat.global](https://www.implantat.global)

1-866-507-9315

[SINdentalusa.com](https://www.SINdentalusa.com)

www.sinimplantsystem.com.br

Visit our social networks:

  @sinimplantgloba  S.I.N. Implant System