



Image 1 – Unitite Surgical Kit

CCUS 20	DRIVER HANDPIECE UNITITE SLIM SHORT
CCUS 24	DRIVER HANDPIECE UNITITE SLIM LONG
CTUS 20	DRIVER HANDPIECE UNITITE SLIM SHORT
CTUS 24	DRIVER HANDPIECE UNITITE SLIM LONG
CCUM 20	DRIVER HANDPIECE IMPL. UNITITE SHORT
CCUM 24	DRIVER HANDPIECE IMPL. UNITITE LONG
CTUM 20	DRIVER HANDPIECE UNITITE MORSE SHORT
CTUM 24	DRIVER HANDPIECE UNITITE MORSE LONG
CCUC 20	DRIVER HANDPIECE UNITITE COMPACT SHORT
CCUC 24	DRIVER HANDPIECE UNITITE COMPACT LONG
CTUC 20	DRIVER HANDPIECE UNITITE COMPACT SHORT
CTUC 24	DRIVER HANDPIECE UNITITE COMPACT LONG
CBD 01	DRIVER BI-DIGITAL
CDH 1224	HEX. SCREWDRIVER 1.2X24
MTM 02	TRANSMUCOSAL METER MORSE
MTMC 02	TRANSMUCOSAL METER MORSE COMPACT
MTMS 02	TRANSMUCOSAL METER MORSE SLIM
IDU 100	SHORT STEERING CYLINDER
IDU 200	LONG STEERING CYLINDER

EXFN	DRIVER HANDPIECE 16
FRLD 2005	DRILL LANCE Ø 2.0MM
FHCD 2015	TWIST DRILL Ø 2,0mm x 15mm
FHCD 3215	TWIST DRILL Ø 3,25mm x 15mm
FHCD 4215	TWIST DRILL Ø 4,25mm x 15mm
FHCD 5215	TWIST DRILL Ø 5,25mm x 15mm
FUM 2915	DRILL UNITITE Ø2.6MM X 15MM
FUM 3515	DRILL UNITITE Ø3.0MM X 15MM
FUM 4315	DRILL UNITITE Ø3.8MM X 15MM
FUM 5015	DRILL UNITITE Ø4.5MM X 15MM
CMRU 29	SCREW TAP Ø 2,9MM
CMRU 35	SCREW TAP Ø 3,5MM
CMRU 43	SCREW TAP Ø 4,3MM
CMRU 50	SCREW TAP Ø 5,0MM
SOPU 20	DEPTH PROBE
TMECC 03	SURGICAL TORQUE RATCHET
CMRUC 40	SCREW TAP Ø4,0MM
CMRUC 50	SCREW TAP Ø5,0MM
CMRUC 60	SCREW TAP Ø6,0MM

CAIXA ORGANIZADORA KIT CIRÚRGICO UNITITE Organizing Box Unitite Surgical Kit

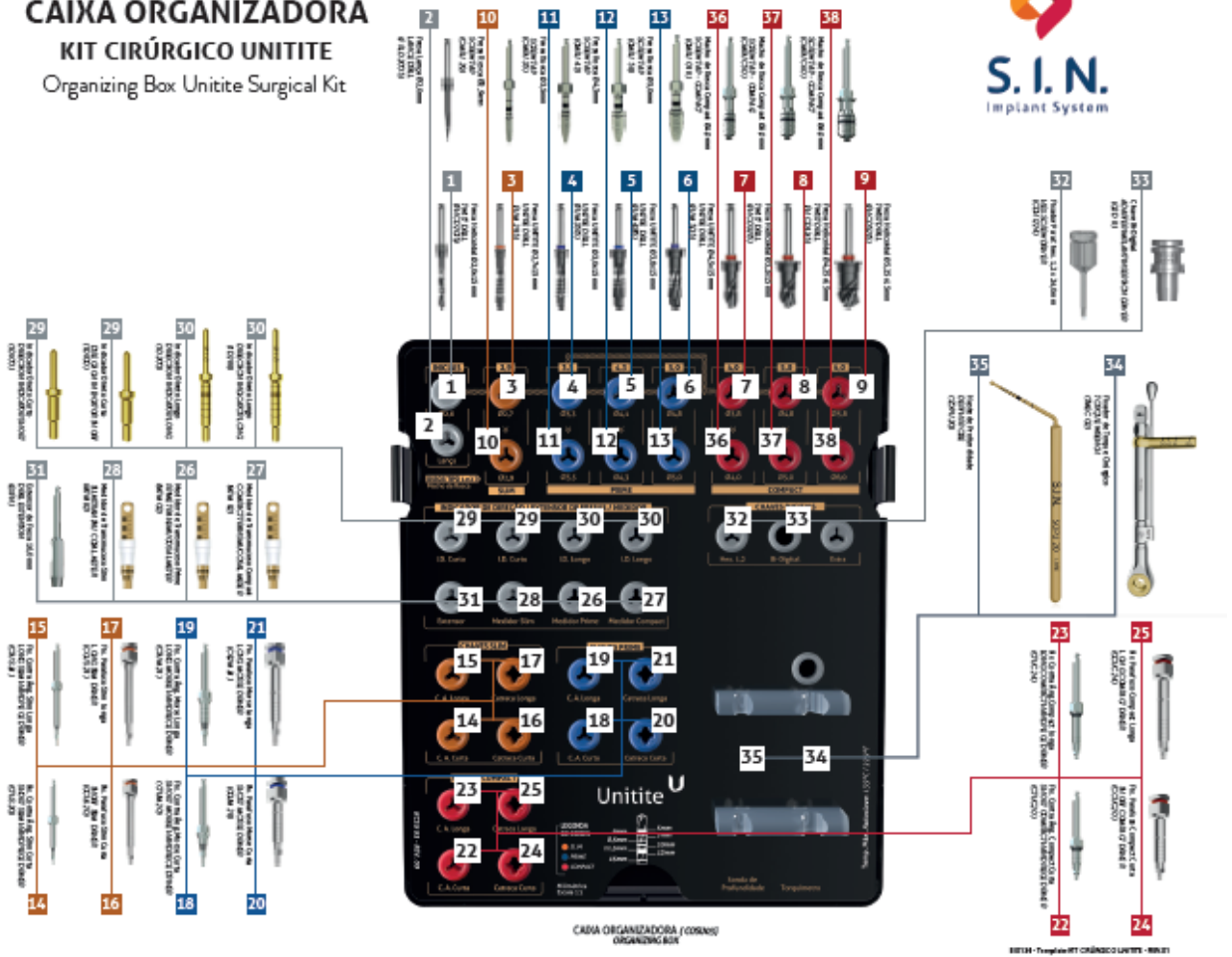

Image 2 – Unitite Surgical Kit with items position

1. DESCRIPTION

Unitite Surgical Kit are reusable rigid containers, comprising a case bottom (or base), a removable inner tray base (tray), and tray lid (lid). The Unitite Guided kit are to be used to organize and protect instruments and accessories that are to be sterilized by the healthcare provider. The lids are manufactured from injection molded Udel® P-1700 polysulfone, the tray base and case bottoms are manufactured from injection-molded polysulfone, and holders of various geometries to position items in the trays are manufactured from molded silicone. The Unitite Guided Surgical kit are provided nonsterile to the end-user.

2. INDICATIONS FOR USE STATEMENT

S.I.N. Instrument Kits are intended to be used to enclose other medical devices that are to be sterilized by a health care provider. S.I.N. Instrument Kits are intended to allow sterilization of the enclosed medical devices. S.I.N. Instrument Kits require the use of a wrap that is FDA cleared to maintain the sterility of the enclosed devices.

The kits are to be enclosed in a sterilization wrap that is FDA cleared for the indicated cycles, and moist heat (steam) sterilized using the following cycle:

Gravity displacement – Exposure at 121 °C for 30 minutes and 30 minutes dry time.

S.I.N. Instrument Kits are intended for sterilization of non-porous loads.

S.I.N. Instrument Kits are recommended not to be stacked during sterilization.

The combined weight of the Unitite Surgical Kit and the associated instruments is 1126 grams.

The weight of the empty Unitite Surgical Kit is 515 grams.

3. APPLICATIONS

The Unitite Surgical Kit is exclusively indicated to assist in the installation of implants of the S.I.N Unitite family and is not compatible with other lines and systems of other manufacturers.

4. CONTRAINDICATIONS

The Unitite Surgical Kit does not present contraindications since its recommendations are followed correctly, as directed in this Instructions for Use and used by a specialized professional, who will be responsible for the adequate planning of the surgical procedure in which the Kit will be used.

5. HANDLING

Once sterilized, instruments should be handled only in a sterile environment by properly trained professionals and wearing appropriate gowning at the time of surgery to install dental implants. Scratches, creases or notches from surgical instruments should be avoided as these factors may increase the possibility of corrosion of the products.

6. KIT ASSEMBLY

To set up this Kit, each reserved space is related to a number from the instrument table; see the image on page 2.

The maximum load configuration is shown in Image 2. The maximum load (weight) configuration is 611 grams, based on the maximum load configuration shown in Table 1. The weight of the empty Kit is 515 grams.

7. SANITATION

Clean the Kit and all instruments right after of each use.

Use the following manual cleaning process only. Automated cleaning has not been validated. Do not use automated cleaning

7.1 Cleaning the Kit

1. Remove manually all surgical instruments from the kit. Remove the kit box parts (lid, tray and bottom).
2. Prepare Prolystica® (STERIS Healthcare) according to manufacturer's recommendation.
3. Immerse the trays into the prepared detergent solution and keep in contact for at least 5 minutes, then using a soft bristle brush, scrub the parts to remove organic matter from the products.
4. Remove trays from detergent solution and rinse with tap water for 1 minute, repeat the rinse for two more times, a total of three rinses of 1 minute each.
5. Visual inspection of each part for cleaning process residue or organic waste from product use.
6. If residue is detected in the product, repeat the cleaning process until the residue is completely removed.
7. Dry with a soft, clean, dry cloth or disposable paper.

7.2 Dismantle Instructions for the Torque Wrench

1. Pull the drive rod backward direction.
2. Remove the ratchet fitting head.
3. Rotate the torque wrench drum counterclockwise until it is fully loosened.
4. Remove the central axis of the torque wrench.
5. Remove the stem with torque.
6. Start the following washing procedure.

7.3 Cleaning the surgical instruments

1. Disassemble the product, if applicable.
2. Prepare Prolystica® (STERIS Healthcare) according to the manufacturer's recommendation.
3. Immerse all parts of the product into the prepared detergent solution and keep in contact for at least 5 minutes, then using soft bristle brush, scrub the parts to remove organic matter from the products.
4. Remove parts from detergent solution and rinse with tap water for 1 minute, repeat the rinse for two more times, a total of three rinses of 1 minute each.
5. Visual inspection of each part for cleaning process residue or organic waste from product use.
6. If residue is detected in the product, repeat the cleaning process until the residue is completely removed.
7. Dry with a soft, clean, dry cloth or disposable paper.

7.4 Placing the instruments into the Kit

Place cleaned instruments into the Kit, according to the tray layout illustration and instruments table. Proceed to sterilization instructions (Section 8).

8. STERILIZATION

The Kit is to be enclosed in a sterilizable wrap that is FDA cleared for the indicated cycles.

Please use for sterilization only the steam sterilization according to the following parameters:

	Cycle (gravity)
Sterilization Time	30 minutes
Sterilization Temperature	121°C
Drying Time	30 minutes

1. Please store the Kit after sterilization in the sterilization packaging at a dry and dust-free place.
2. The flash/ immediate use sterilization procedure must not be used.
3. Do not use dry heat sterilization, radiation sterilization, formaldehyde and ethylene oxide sterilization, as well as plasma sterilization.

9. PRECAUTIONS

The Unitite Surgical Kit requires specialized surgical procedures, only to be used by qualified dental surgeons, including: diagnosis, preoperative planning and surgical protocol. The use of the product without knowledge of the proper techniques and/ or inadequate procedures and conditions may harm the patient leading to unsatisfactory results.

For drills cutters, it is recommended to use up to 20 to 30 perforations, which are:

- 20 high-density bone perforations;
- 30 perforations in low-density bones.

Do not stick labels, tapes, as well as write, or mark the surface of the product.

It is recommended to immediately wash and sterilize the kit and its components after use.

10. ADVERSE EFFECTS

The Unitite Surgical Kit is used to aid in the installation of dental implants, so adverse effects will occur only if the choice of instruments is inadequate.

11. STORAGE CONDITIONS

This product should be stored, in its original packaging, in a clean and dry location, in a maximum temperature of 35°C and protected from direct sunlight.

12. LIFE CYCLE

This product is recommended for up to 250 uses, provided that the recommended conditions of use are followed.

Regardless of the number of times the instrument has been used, the professional must always evaluate its condition after each use. Visually inspect the lid, tray, and case bottom to ensure there is no cracking, deformation, or other damage.











Visually inspect that all labeling printed on the lid and tray is clear and legible.

Verify that the lid, tray, and case bottom can be assembled and that the Lid latches securely to the case bottom.

Do not use the Kit if any of the above or any other damage is observed, regardless of the number of cycles of use.

Symbols Glossary

ANSI/AAMI/ ISO 15223-1:2016 Medical devices – Symbols to be used with medical device labels, labeling and information to be supplied – Part 1: General requirements.

Symbol	Title of Symbol (Reference Number)	Meaning of Symbol
	Caution (5.4.4)	Indicates the need for the user to consult the instructions for use for important cautionary information such as warnings and precautions that cannot, for a variety of reasons, be presented on the medical device itself.
	Keep away from sunlight (5.3.2)	Indicates a medical device that needs protection from light sources.
	Upper limit of temperature (5.3.6)	Indicates the upper limit of temperature to which the medical device can be safely exposed.
	Keep dry (5.3.4)	Indicates a medical device that needs to be protected from moisture.
	Do not use if package damaged (5.2.8)	Indicates a medical device that should not be used if the package has been damaged or opened.
	Consult instructions for use (5.4.3)	Indicates the need for the user to consult the instructions for use.
	Date of manufacture (5.1.3)	Indicates the date when the medical device was manufactured
	Manufacturer (5.1.1)	Indicates the medical device manufacturer.
	Non-sterile (5.2.7)	Indicates a medical device that has not been subjected to a sterilization process.
	Catalogue number (5.1.6)	Indicates the manufacturer's catalogue number so that the medical device can be identified.
	Batch code (5.1.5)	Indicates the manufacturer's batch code so that the batch or lot can be identified.

Caution: Federal (USA) law restricts this device to sale by or on the order of a licensed dentist or physician.

DEVELOPED AND MANUFACTURED BY:

S.I.N. Sistema de Implante Nacional S/A

CNPJ [Corporate Taxpayer's Registry]: 04.298.106/0001-74

Rua Soldado Ocimar Guimarães da Silva, 421 –

Vila Rio Branco CEP: 03348-060 - São Paulo - SP - Brazil

Phone/Fax: +55 (11) 2169-3000

SERVICE TO PROFESSIONALS

0800 770 8290 +55 (11) 2169-3000

www.sinimplante.com.br

e-mail: sin@sinimplante.com.br